

RELOADING 21

LEE
LEE PRECISION INC.

Introducing
**THE NEXT REVOLUTION
IN PRIMING**

**THE WORLD'S FIRST AUTOMATICALLY CASE FED
SHELLHOLDER-LESS PRIMING TOOL**

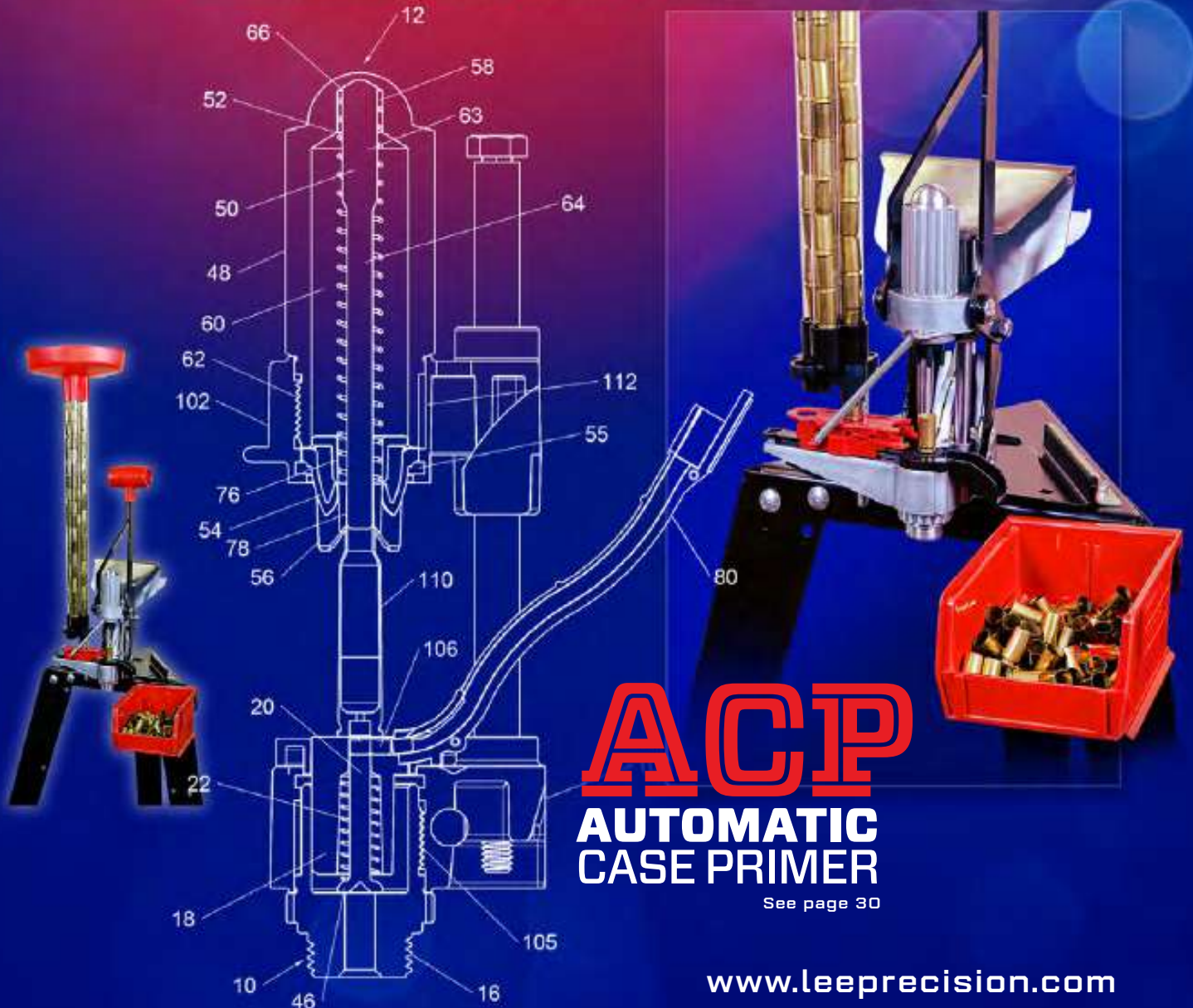

| | |
|-------|---------------------------------------------------------------------------------------------------------------|
| 2-3 | Lee Loader Reloading Basics |
| 4 | Reloading Stand Bench Plate |
| 5 | Modern Reloading II |
| 6-7 | Pistol Reloading Dies Carbide Factory Crimp Dies |
| 8 | Pistol Dies Size Chart |
| 9 | Spline Drive Lock Rings Shellholders |
| 10 | Rifle Die Selection |
| 11 | Rifle Factory Cimp Dies |
| 12-13 | Rifle PaceSetter Dies Rifle Collet Ultimate Die Sets |
| 14-15 | Rifle Dies Size Chart |
| 16-17 | Reloading Press Overview Single Stage and Progressive |
| 18 | Breech Lock Reloader Breech Lock Hand Press & Kit Ram Prime Breech Lock Ram Prime |
| 19 | Breech Lock Challenger Press 50th Anniversary Kit Breech Lock Challenger Kit |
| 20 | Classic Cast Press 50 BMG Press Kit |
| 21 | Classic Turret Press and Kit |
| 22 | Value Turret Press and Kit |
| 23 | Progressive Press Accessories |
| 24 | Pro 1000 Pro 4000 |
| 25 | Pro 4000 Load-Master |
| 26 | The APP Automatic Processing Press |
| 27 | The APP Accesories |
| 28 | Quick Trim Dies Case Trim Tools |
| 29 | Quick Trim & Case Length Gauge Charts Bulge Buster Kit |
| 30 | ACP Auto Bench Prime |
| 31 | Auto-Prime Ergo Prime Priming Tool Kits Shellholders |
| 32 | Deluxe Perfect Powder Measure Perfect Powder Measure Safety Scale Powder Funnel Powder Measure Kit |
| 33 | Pro Auto Disk Powder Measure Auto Drum Powder Measure |
| 34 | Electric Melters |
| 35 | Lubrication and Sizing |
| 36 | Rifle Bullet Molds |
| 37 | Pistol Bullet Molds |
| 38 | Black Powder Bullet Molds |
| 39 | Slug Molds Buckshot Molds Load-All II |



*The kit that started it all,
The Classic Lee Loader*

* Calibers requiring considerable force for sizing.

Classic Lee Loader

More shooters have chosen the famous Lee Loader for their first reloading tool than any other. They realize it is all they need for good, accurate ammunition. In fact, at one time ammunition loaded with a Lee Loader held a world record listed in the Guinness Book of World Records for more than seven years. Millions upon millions of rounds have been reloaded with the famous Lee Loader. It's the perfect tool for those who wish to simply try reloading, because it will pay for itself in just an hour or two. Find out for yourself how much fun it is to reload with the Lee Loader. Everything you need to begin loading one caliber!

LEE LOADER 41.98

| SIZING TYPE | LEE LOADER SIZES | |
|-------------|---------------------|-------|
| NECK SIZE | 223 Remington | 90232 |
| | 243 Winchester | 90235 |
| | 270 Winchester | 90240 |
| | 7.62x54 Russian | 90243 |
| | 30/30 Win (30 Rem.) | 90244 |
| | 308 Winchester | 90245 |
| FULL LENGTH | 30/06 Springfield | 90248 |
| | 303 British | 90247 |
| | 45/70 Government | 90264 |
| NECK SIZE | 9mm Luger | 90254 |
| | 38 Special | 90257 |
| FULL LENGTH | 357 Magnum | 90258 |
| | +44 Magnum | 90260 |
| NECK SIZE | +45 ACP | 90262 |
| | +45 Colt | 90263 |

RELOADING

SIZE

HANDGUN



Pistol Sizing Die

REMOVING spent primer and **RESIZING** case can be accomplished by using any reloading press



Breech Lock Challenger Press
pg 19

PRIME

INSTALL PRIMER

Can be done on press or by hand



On press: Prime with Lever Prime System
pg 19

Hand Prime with New Auto-Prime
pg 31



Priming with Lee Auto-Bench Prime
pg 30

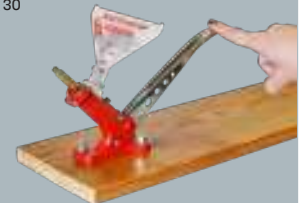

The next revolution in priming

Press Priming with the new Lee ACP Automatic Case Primer
pg 30



FULL LENGTH SIZE

OR

COLLET NECK SIZE

TRIM

RIFLE

NOTICE how the case neck is sized as case is withdrawn from die over the expander

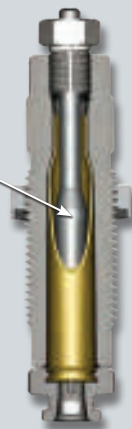

Rifle Full Length Sizing Die
LUBRICATE an inspected, clean case.



Rifle Collet Necksizing Die
No lube required. Cases must be fired through your gun only.

FOR SAFETY SAKE

CHECK CASES for proper trim length. Chamfer inside case neck to allow easy bullet installation.

Case Conditioning Kit
pgs 28-29



Deluxe Quick Trim, trim and chamfer simultaneously
pg 28-29

RELOADING IS AN ENJOYABLE HOBBY, saves you money — and no manufacturer saves you more than Lee Precision, Inc. **Our mission is simple: produce the best American made value in reloading tools.** Our great prices come from patented, innovative designs. We are thankful to say that Lee Precision products are cast, machined and assembled in the USA. A reloading press and a set of Lee Dies are all you need to start reloading. Lee Dies come complete with powder dipper, shell holder and instructions, along with comprehensive load data that tells

you how much and what type of powder to use. Dies and presses last a lifetime, so buying what your budget allows makes the most sense. For those with a workbench, consider our Lee Bench Plate for the ultimate convenience in mounting your presses. If you don't have a workbench, consider the Lee Reloading Stand, compact and very sturdy. If you have no loading equipment and are just getting started, you must consider that these basic steps need to be taken below.

Check out our complete line of reloading and casting equipment on our website, then visit your local merchant. If not blessed with a local dealer, one of the many online dealers will quickly and economically fill your order.

SEQUENCE

CHARGE

EXPAND CASE MOUTH AND CHARGE POWDER.
Lee handgun dies are unique in that you can charge powder during this operation



HANDGUN Powder Through Expanding Die



Auto Drum Powder Measure pg 33

SEAT & CRIMP

HANDGUN Bullet Seating Die

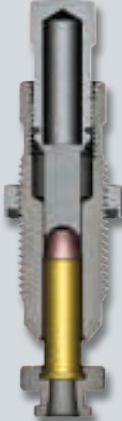

SEAT AND CRIMP THE BULLET

OPTIONAL



HANDGUN Carbide Factory Crimp Die
Easy to adjust crimp and carbide ring post sizes the case. pg 7

CHARGE

CHARGE POWDER
Powder Funnel and Dippers pg 32



Deluxe Perfect Powder Measure pg 32



SEAT

RIFLE Easy Adjust Dead Length Bullet Seating Die



SEAT THE BULLET

CRIMP

FACTORY CRIMP DIE
In most circumstances will improve velocity, uniformity and in all cases, factory-like utility & dependability. pg 11



Lee Reloading Stand

At last, a reloading stand built just for your reloading needs. The sturdy powder coated steel stand places your press at the perfect counter stool or standing height. Three-leg design assures absolute stability regardless of the floor condition. Rubber tipped legs suitable for any surface.

The thick steel top is fitted with the patented, quick change Lee Bench Plate System with steel base block to fit all Lee metallic presses.

The stand also includes a sturdy steel shelf with two bench plate receivers that will neatly and securely store your extra presses or mountable accessories.

Each leg has eight mounting holes that allow you to accessorize your stand with a multitude of bins, shelves or accessory racks.

Dimensions 39" high x 26" wide x 24" deep

90688 172.00

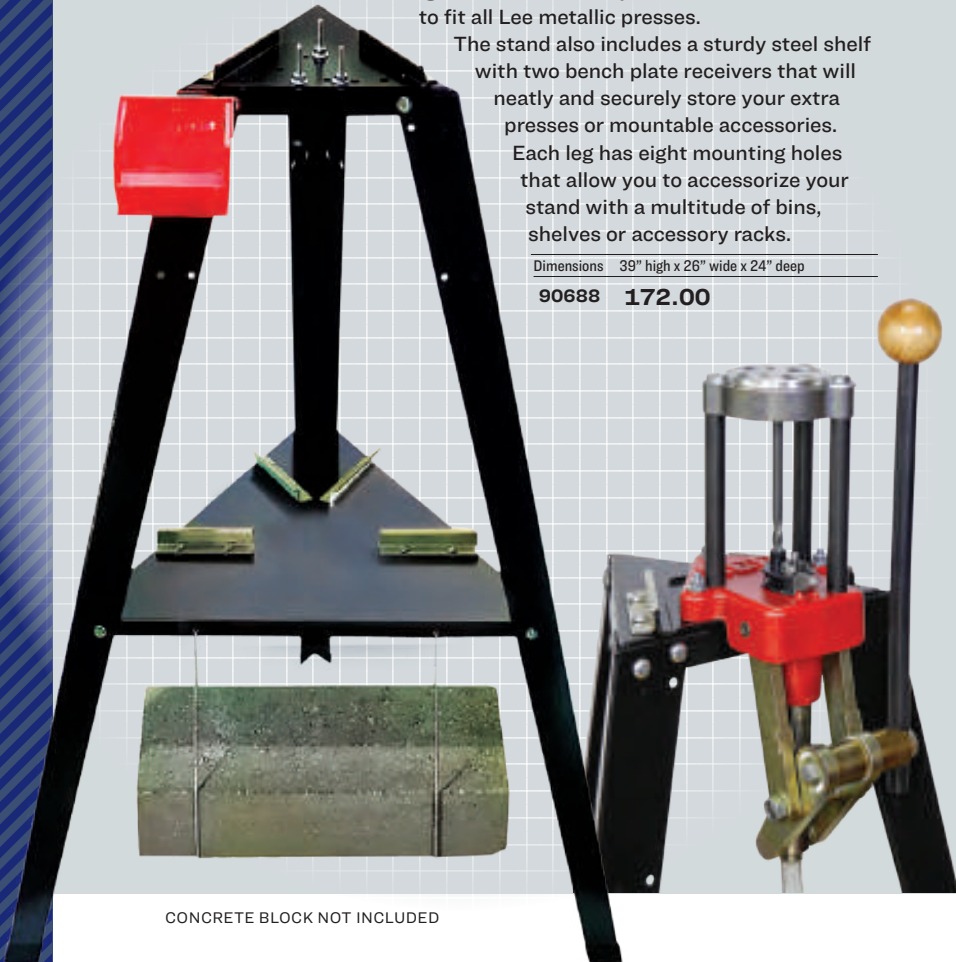

CONCRETE BLOCK NOT INCLUDED

ACCESSORIES



Die Rack

Sturdy steel rack with fasteners designed for the Lee Reloading stand. Conveniently holds your dies at the ready, especially helpful when loading small batches of ammo with frequent die changes. Can also be wall or bench mounted.

90680 14.00



Bin and Bracket

Sturdy steel bracket and parts bin. Includes fasteners to allow direct mounting to the Lee Reloading stand, or workbench. Perfect for holding bullets, cases and loaded rounds.

90687 14.00

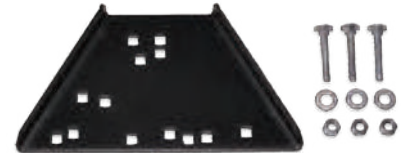

Steel Base Block

Rigid, powder coated steel construction. First choice for mounting all current Lee Presses. Works with the Lee Reloading Stand and Bench Plate. Fasteners for mounting one Lee reloading press are included.

90267 15.00

LEE BENCH PLATE

JUST REMOVE

AND REPLACE

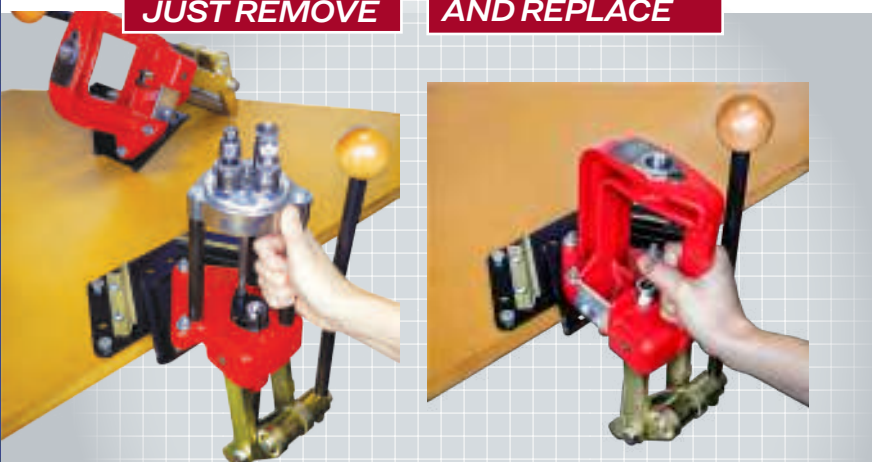

Patented design allows instant press change. So sturdy you can resize the monster 50 BMG case, then quickly switch to a smaller press for priming or other operations. Trapezoidal base block slides into perfect register and made immovable with the quick tightening of four bolts.

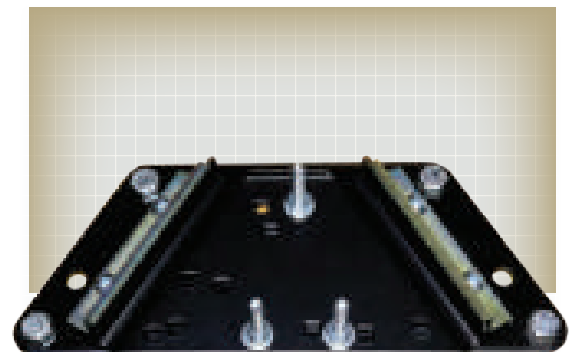

Includes steel base block with holes to mount any Lee press. Powder coated, thick steel plate mounts quickly and securely to any bench or tabletop. Wide steel plate distributes load, adding rigidity to the lightest bench top.

Lee Bench Plate 90251 32.00

SELECTING THE BEST HANDGUN DIE SET

Lee handgun dies feature a carbide sizing die — simply the best way to resize straight walled handgun cartridges.

Select the **DELUXE PISTOL 4-DIE SET** when using mixed range brass. The Deluxe Set includes the Carbide Factory crimp die. This die allows you to separate bullet seating from the crimping operation. It makes setup much easier and the die has the added feature of a carbide resizer that does a finishing sizing pass on the completed round. This final sizing guarantees that any case that passes through the die will freely and reliably chamber in any gun. The **CARBIDE & STEEL THREE DIE SETS** work fine when using a quality controlled source of brass, like cases fired only in your gun. More care is required when adjusting the bullet seat and crimp die, as seating and crimping occur simultaneously. Bullet diameter control is important when not using the factory crimp.

Lee Dies reload cartridges better, easier, more accurately and with fewer problems!

Keep your dies set, and at the ready in the 4-die box.



CARBIDE FACTORY CRIMP DIE

Carbide ring in base resizes any portion of case that exceeds factory new dimensions. Floating crimp ring is finger adjustable to provide the perfect crimp.

HARDENED STEEL SHELLHOLDER

Others charge \$14.50 for this item!

Exclusive feature to Lee
POWDER MEASURE & CHARGE TABLE

Exclusive feature to Lee
POWDER THROUGH EXPANDING DIE

Only Lee Dies permit charging the case while expanding the case mouth. Every Lee Pistol Die Set includes this **Powder Through Expanding Die** at no extra cost. The powder funnel adapter can be replaced with a Lee case actuated Powder Measure (pg. 33) for fully automatic powder charging while the case mouth is being expanded.

RELOADING DIES shown with COLOR CODED SPLINE DRIVE BUSHINGS installed.
See page 8

CONTOUR GROUND CARBIDE SIZING DIE

BULLET SEAT & FEED DIE



Carbide Sizer

All Lee straight walled pistol dies have tungsten carbide sizer rings. Carbide is so hard that it can only be ground and polished with diamond wheels.

This hard diamond polished surface eliminates the need for case lubrication—they will never wear out. Exclusive contour grind sizes closer to the rim than any other brand.

The collet held decapper is nearly unbreakable even if you misadjust it or deprime crimped military cases.

The decapper clamp accurately centers the decapper in the die. Should you over stress it for any reason, it harmlessly slides up without breaking. Easily reset with no limit to the amount of times it can be reset.



Bullet Seat and Feed Die

Universal free floating seating plug works with nearly any point style bullet. No need to change seater plugs for different nose types. Finger adjustable seating depth eliminates fumbling with pliers, lock nuts and screwdrivers to make simple seating depth adjustment. Die is tapered on end for use with automatic bullet feeders.



ONLY LEE DIES COME COMPLETE WITH POWDER MEASURE and CHARGE TABLE

LEE
exclusive feature

PISTOL DIE SETS

LEE DELUXE PISTOL 4-DIE SET 69.98

INCLUDES CARBIDE FULL LENGTH SIZING DIE, POWDER THROUGH EXPANDING DIE, BULLET SEAT AND FEED DIE AND CARBIDE FACTORY CRIMP DIE.

Combines the world's most popular carbide three-die set with the Lee Carbide Factory Crimp Die at a great price. No other die set at any price produces more reliable or accurate ammo.

By separating the seating and crimping operation, you will benefit by greatly simplified adjustment. More importantly, the Carbide Factory Crimp Die post sizes your case, assuring that any round that passes through the die will chamber properly in your gun. This, plus all the other exclusive features — make this the best die set money can buy!

LEE CARBIDE PISTOL 3-DIE SET 44.98

INCLUDES CARBIDE FULL LENGTH SIZING DIE, POWDER THROUGH EXPANDING DIE AND BULLET SEAT AND FEED DIE.

We use a solid carbide insert, ground to a special contour that does not leave the objectional belt mark on the case, common to ordinary carbide dies. With a carbide sizer, no case lube is needed, and you don't even have to clean your cases.

**NO NEED FOR A TAPER CRIMP DIE;
BETTER ACCURACY WITH LEE DIES.**

Taper crimp dies are used to correct the problems caused by the improper expanding plug design or adjustment. They distort the bullet shank and reduce accuracy. Because the Lee Expander flares the minimum amount, consistent with easy bullet insertion, all of the flare is removed with the bullet seating die, thus eliminating the need for a taper crimp die.

LEE STEEL PISTOL 3-DIE SET 44.98

INCLUDES STEEL FULL LENGTH SIZING DIE, POWDER THROUGH EXPANDING DIE, BULLET SEAT AND FEED DIE, AND RESIZING LUBRICANT PACKET

Same features as our premium carbide sets, except the case must be lubricated.

STORAGE IS EASY

LEE DIES ARE PACKED IN A FITTED BOX THAT ALLOWS DIES TO BE RETURNED TO THE BOX ADJUSTED WITH OR WITHOUT THE LEE BREECH LOCK BUSHING OR SPLINE DRIVE BUSHING INSTALLED



Short Bottle Neck Collet Style Factory Crimp Die

Incorporates a collet to apply a rifle type crimp to the case. Makes these very difficult to crimp cartridges a delight to reload. Bullets do not need a crimp groove, as the collet is so powerful it will form one.

BOTTLE NECK PISTOL FACTORY CRIMP DIE

25.00

Taper Crimp Die

The Lee Taper Crimp Die is hardened steel, designed to overcome crimp problems caused by poor die design. These dies offer little or no advantage when used with 1986 or newer Lee Dies. Jacketed bullets must have a crimp groove.

TAPER CRIMP DIE 13.98

Collet Style Factory Crimp Die

Popular with cast bullet shooters that wish to use oversize bullets; also very popular when reloading heavy recoiling revolvers. No other crimping system can apply as secure a crimp at the Lee Collet style Factory Crimp Die. No crimping groove required in jacketed or cast bullets, this die is so powerful it forms a crimp groove if one is not present.

COLLET STYLE CRIMP DIE 15.98

CARBIDE FACTORY CRIMP DIE

Lee Carbide Factory Crimp Die

A CARBIDE SIZER SIZES THE cartridge while being crimped, so every round will positively chamber freely with factory like dependability. The adjusting screw quickly and easily sets the desired amount of crimp. It

is impossible to buckle the case as with a conventional bullet seating die. Trim length is not critical so this extra operation takes less time than it would if cases were trimmed and chamfered.

Revolver dies roll crimp with no limit as to the amount. A perfect taper crimp is applied to auto-loader rounds. The crimper cannot be misadjusted to make a case mouth too small to properly head-space. A firm crimp is essential for dependable and accurate ammunition—it eliminates the problems of poor ignition of slow burning magnum powders.

CARBIDE FACTORY CRIMP DIE 26.98



INCLUDED WITH DELUXE 4-DIE SETS

FOR HANDGUN AMMUNITION THAT MUST WORK

| | CRIMP STYLE | CARBIDE FACTORY CRIMP DIE | SHORT BOTTLE NECK COLLET STYLE FACTORY CRIMP DIE | COLLET STYLE FACTORY CRIMP DIE | TAPER CRIMP DIE |
|--------------------------------------------------|-------------|---------------------------|--------------------------------------------------|--------------------------------|-----------------|
| 5.7x28 FN | | N/A | 90725 | N/A | N/A |
| 22 TCM | | N/A | 90087 | N/A | N/A |
| 30 M1 Carbine · 32/20 | | N/A | N/A | 90421 | N/A |
| 30 Luger | | N/A | 90175 | N/A | N/A |
| 30 Tokarev & 30 Mauser | | N/A | 90086 | N/A | N/A |
| 32 ACP · 32 S&W Long 32 H&R Mag · 327 Federal | ROLL | 90067 | N/A | N/A | N/A |
| 9mm Makarov | TAPER | 90807 | N/A | N/A | N/A |
| 9mm Luger | TAPER | 90860 | N/A | N/A | 90780 |
| 357 Sig | | N/A | 90076 | N/A | N/A |
| 38 Super & 38 ACP | TAPER | 90866 | N/A | N/A | 90780 |
| 380 Auto | TAPER | 90867 | N/A | N/A | 90780 |
| 38 Special | ROLL | 90861 | N/A | N/A | 90781 |
| 357 Magnum | ROLL | 90861 | N/A | 90813 | 90781 |
| 40 S&W & 10mm Auto | TAPER | 90862 | N/A | N/A | 90782 |
| 41 Magnum | ROLL | 90416 | N/A | N/A | N/A |
| 44 Special | ROLL | 90863 | N/A | N/A | 90784 |
| 44 Magnum | ROLL | 90863 | N/A | 90930 | 90784 |
| 44 Russian | ROLL | 90863 | N/A | N/A | N/A |
| 45 Colt | ROLL | 90865 | N/A | 90302 | 90786 |
| 45 ACP · 45 Auto Rim · 45 GAP · 45 Win Mag | TAPER | 90864 | N/A | N/A | 90785 |
| 400 CorBon | | N/A | 90173 | N/A | N/A |
| 455 Web Mark II | | N/A | N/A | N/A | 90785 |
| 454 Casull | ROLL | 90865 | N/A | N/A | 90786 |
| 460 S&W | | N/A | N/A | 90926 | N/A |
| 500 S&W | | N/A | N/A | 90931 | N/A |

FREE SHELLHOLDER

included where shown

The price of Lee Dies include a FREE SHELL HOLDER of the proper size. Some manufacturers charge \$14.50 extra for this necessary part.



| | DELUXE PISTOL 4-DIE SET P 7 | CARBIDE 3-DIE SET P 7 | STEEL 3-DIE SET P 7 | SIZING DIE ONLY | POWDER THROUGH EXPANDING DIE | TAPER CRIMP DIE P 9 | FACTORY CRIMP DIE P 9 | COLLET STYLE CRIMP DIE P 9 | CASE LENGTH GAUGE P 29 | UNIVERSAL SHELLHOLDER P 7 | PRIMING TOOL SHELLHOLDER P 31 | QUICK TRIM DIE BODY P 28 |
|----------------------------|-------------------------------|-------------------------|-----------------------|-----------------|------------------------------|-----------------------|-------------------------|------------------------------|--------------------------|-----------------------------|---------------------------------|----------------------------|
| | 69.98 | 44.98 | 44.98 | 28.98 | 13.98 | 13.98 | 20.00-26.98 | 15.98 | 7.50-12.00 | 5.98 | 2.98 | 15.00-20.00 |
| 22 TCM [2-Die Set] | | | 90803 | 91032 | N/A | | 90087 | | | 90521 | 90204 | 91373 |
| 5.7 x 28 [2-Die Set] | | | 90603 | 91129 | N/A | | 90725 | | 90219 | 90002 | 90017 | 91363 |
| 25 ACP | | 90568 | | 91204 | 91141 | | | | | 90002 | 90017 | |
| 30 M1 Carbine | | 90626♦ | | 90617♦ | 90494 | | | 90421 | 90135 | 90524 | 90207 | 90365 |
| 30 Luger | | | 90754 | 91212 | 91142 | | 90175 | | | 90004 | 90023 | |
| 30 Mauser | | | 90755 | 91213 | 91142 | | 90086 | | | 90004 | 90023 | |
| 7.62 Tokarev | | | 90769 | 91214 | 91142 | | 90086 | | 91336 | 90004 | 90023 | |
| 32 ACP | | 90622 | | 90621 | 91144 | | 90067 | | 91338 | 90524 | 90207 | |
| 32 S & W | | 90696 | | 90621 | 91144 | | | | 91311 | 90521 | 90204 | |
| 32 S & W Long | | 90624 | | 90621 | 90490 | | 90067 | | 90169 | 90521 | 90204 | |
| 32 H & R Mag / 327 Federal | | 90809 | | 90621 | 91162 | | 90067 | | 91310 91303 | 90521 | 90204 | |
| 32/20 | | | 90751 | 91221 | 91145 | | | 90421 | 90146 | 90523 | 90206 | |
| 38/40 | | | 90761 | 91215 | 91146 | | | 90852 | | 90001 | 90272 | |
| 9mm Makarov | | 90176 | | 91206 | 91147 | | 90807 | | 90684 | 90004 | 90023 | 90181 |
| 9mm Luger | 90963 | 90509 | | 90548 | 90580 | 90780 | 90860 | | 90153 | 90004 | 90023 | 90032 |
| 357 Sig | | | 90270 | 91216 | 91148 | | 90076 | | 91317 | 90004 | 90023 | |
| 38 Short / Long Colt | | 90276 | | 91207 | 91149 | | | | 91321 | 90518 | 90201 | |
| 38 Super / 38 ACP | | 90623 | | 90619 | 91168 | 90780 | 90866 | | 90217 | 90004 | 90023 | |
| 380 Auto | 90447 | 90625 | | 90618 | 90492 | 90780 | 90867 | | 90155 | 90521 | 90204 | 90025 |
| 38 S & W | | 90569 | | 90619 | 91149 | | | | 90156 | 90518 | 90201 | |
| 38 Special / 357 Magnum | 90964 | 90510 | | 90530 | 90581 | 90781 | 90861 | | 90157 90158 | 90518 | 90201 | 90085 90088 |
| 40 S & W / 10mm Auto | 90965 | 90799 | | 91208 | 90620 | 90782 | 90862 | | 90154 90127 | 90004 | 90023 | 90033 90193 |
| 41 Mag | | 90628 | | 91220 | 91169 | | 90416 | | 90159 | 90526 | 90209 | 90226 |
| 429 Desert Eagle | | | 90796 | 91504 | 91171 | | | | | 90528 | 90211 | |
| 44 Special / 44 Magnum | 90966 | 90516 | | 90531 | 90583 | 90784 | 90863 | | 90160 90161 | 90528 | 90211 | 90107 90125 |
| 44 Russian | | 90293 | | 90531 | 91152 | | 90863 | | | 90528 | 90211 | |
| 44/40 | | | 90564 | 91217 | 91153 | | | 90854 | 90168 | 90001 | 90272 | |
| 45 Colt | 90967* | 90514* | | 90533 | 90586 | 90786 | 90865 | 90302 | 90163 | 90528 | 90211 | 90145 |
| 45 ACP | 90968 | 90513 | | 90532 | 90585 | 90785 | 90864 | | 90162 | 90519 | 90202 | 90073 |
| 45 Auto Rim | | 90808 | | 90532 | 90585 | 90785 | 90864 | | | 90199 | 90213 | |
| 45 Schofield | | 90323 | | 90533 | 91154 | 90785 | | | | 90001 | 90272 | |
| 400 Cor Bon | | | 90430* | 91218 | 91155 | | 90173 | | | 90519 | 90202 | |
| 455 Web Mark II | | 90764 | | 90533 | 91156 | 90785 | | | | 90522 | 90205 | |
| 45 Win Mag | | 90810 | | 90532 | 90585 | 90785 | 90864 | | | 90520 | 90203 | |
| 454 Casull | | 90795 | | 90533 | 90586 | 90786 | 90865 | | 90992 | 90528 | 90211 | 90174 |
| 45 Gap | | 90498 | | 90532 | 91156 | | 90864 | | 91473 | 90519 | 90202 | |
| 460 S & W | | 90344 | | 91209 | 91157 | | | 90926 | 90220 | 90001 | 90272 | |
| 480 Ruger ‡ | | 90499 | | 91210 | 91158 | | 91242 | | 90018 | 90522 | 90205 | |
| 50 Action Express | | | 90329 | 91219 | 91159 | | | | 91327 | 90528 | 90211 | |
| 500 S&W Mag | | 90288 | | 91211 | 91159 | | | 90931 | 90019 | 90003 | 90200 | 90178 |

HAVE A BREECH LOCK PRESS?

Breech lock bushings fit all Lee Breech Lock presses. Allows instant, accurate die changes.

Breech Lock Bushings



90600 2-Pk 11.98
Perfect with Lee Lock Rings



Spline Drive Bushings

Breech lock quick change bushing with integral lock collar provides unmatched precision and convenience when adjusting dies. Split clamp positively locks die into position.

90063 2-Pk 16.00

Buy more for greater savings



90042 3-Pk 21.00

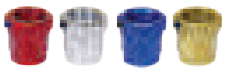

90095 4-Pk 25.00

COLOR CODED FOR QUICK, POSITIVE DIE SELECTION

‡ Can be used to load magnum cases † Can be used to load maximum cases * can be used to load the 475 Linebaugh † can be used to load the 454 Casull ♦ 30 M-1 Carbine \$18.00 extra
* These dies do not include load data S/O Special Order Factory Direct

LEE ULTIMATE SPLINE DRIVE LOCK RINGS

are the perfect choice when using older style presses that require screwing your dies in and out for every operation. The new split clamp spline drive makes all other lock rings obsolete and clumsy to use.

The socket head cross bolt, even when lightly tightened, applies a vise-like grip on your dies. No tiny set screws that easily strip or damage your die threads.

We added the famous Lee "O" ring because, no matter how securely you have the lock ring clamped to the die, it will loosen in the press frame during operation without the friction of the "O" ring. The "O" ring allows you to finger tighten into your press and will never loosen during operation. Kit includes a wrench for easy die removal.

ULTIMATE LOCK RINGS

90566 3 pack with wrench 10.98

91640 4 pack color coded. Lock ring wrench sold separately 14.98

LOCK RING WRENCH

90093 2.98

A handy, compact wrench makes the new lock rings a delight to use. Spline drive lock rings are now standard equipment on all Lee dies. Update older Lee Dies or competitor's dies.

SPLINE DRIVE LOCK RINGS (3-PACK)

90534 Lock ring wrench sold separately 4.98

NOW STANDARD ON ALL LEE DIES. These lock rings are perfect for presses equipped with Quick change die bushings or removeable die heads found on most progressive and our turret presses. Smallest

outside diameter lock rings available. Captive friction "O" ring provides immovable die position with just finger tightening. Handy, no tool required die adjustment.

WORKS ON TIGHT TOOLHEADS

| SHELL HOLDER | FOR PRESSES 5.98 | HOLDER | | PISTOL | |
|--------------|------------------|--------|----------------------|--------|----------------------|
| | | | | | |
| #1 | 90518 | 15 | 5.7 x 28 | 1 | 22 Rem. Jet |
| #2 | 90519 | 15 | 25 ACP | 1 | 25 ACP |
| #3 | 90520 | 19 | 30 Luger | 1 | 256 Win. Magnum |
| #4 | 90521 | 19 | 30 Mauser | 4 | 32 Short Colt |
| #5 | 90522 | 4 | 32 Long Colt | 4 | 32 Long Colt |
| #6 | 90523 | 4 | 32 S & W | 4 | 32 S & W |
| #7 | 90524 | 4 | 32 S & W Long | 7 | 32 ACP |
| #8 | 90525 | 7 | 32 ACP | 4 | 32 Colt N.P. |
| #9 | 90526 | 4 | 380 Auto | 4 | 380 Auto |
| #10 | 90527 | 19 | 9mm LUGER | 19 | 9mm LUGER |
| #11 | 90528 | 1 | 38 S & W | 1 | 38 S & W |
| #12 | 90529 | 1 | 38 Colt N.P. | 1 | 38 Colt N.P. |
| #13 | 90199 | 19 | 38 Super Auto | 19 | 38 Super Auto |
| #14 | 90001 | 19 | 38 ACP | 19 | 38 ACP |
| #15 | 90002 | 1 | 38 Short Colt | 1 | 38 Short Colt |
| #16 | 90003 | 1 | 38 Long Colt | 1 | 38 Long Colt |
| #17 | 91497 | 1 | 38 Special · 357 Mag | 1 | 38 Special · 357 Mag |
| #18 | 91498 | 19 | 357 Sig | 19 | 357 Sig |
| #19 | 90004 | 2 | 357 Auto Magnum | 2 | 357 Auto Magnum |
| #20 | 91499 | 19 | 40 S&W · 10mm Auto | 19 | 40 S&W · 10mm Auto |
| #21 | 90599 | 1 | 41 Long Colt | 1 | 41 Long Colt |
| #22 | 91500 | 19 | 41 Action Express | 19 | 41 Action Express |
| #23 | 91501 | 9 | 41 Magnum | 9 | 41 Magnum |
| #24 | 91502 | 11 | 44 S&W Spl · 44 Mag | 11 | 44 S&W Spl · 44 Mag |
| #25 | 91503 | 11 | 44 S & W Russian | 11 | 44 S & W Russian |
| | | 2 | 44 Auto Mag. | 2 | 44 Auto Mag. |
| | | 2 | 45 Auto | 2 | 45 Auto |
| | | 11&14 | 45 Colt | 11&14 | 45 Colt |
| | | 11 | 454 Casull | 11 | 454 Casull |
| | | 14 | 460 S&W | 14 | 460 S&W |
| | | 5 | 455 Webley | 5 | 455 Webley |
| | | 13 | 45 Auto Rim | 13 | 45 Auto Rim |
| | | 3 | 45 Win. Magnum | 3 | 45 Win. Magnum |
| | | 5&16 | 480 Ruger | 5&16 | 480 Ruger |
| | | 5 | 475 Linebaugh | 5 | 475 Linebaugh |
| | | 16 | 500 S&W | 16 | 500 S&W |

Additional cartridges listed on www.leeprecision.com



BIG GUN INSPIRED BREECH LOCK QUICK CHANGE NOW STANDARD ON ALL LEE SINGLE STATION PRESSES

Switch dies with a 1/6 of a turn rather than fourteen or more turns. Loading with a breech lock equipped press is as convenient as a Turret Press when loading small quantities of ammunition. Interrupted three-start thread assures dies will return and lock into the exact same position. If cost is more important than convenience, you can leave the Breech Lock bushing locked in the press and screw dies in and out like a conventional press.



Change dies instantly with a twist of the wrist

Spline Drive Bushings

Breech lock quick change bushing with integral lock collar provides unmatched precision and convenience when adjusting dies. Split clamp positively locks die into position.

90063 2-Pk 16.00

Buy more for greater savings

90042 3-Pk 21.00

90095 4-Pk 25.00

Color coded for quick, positive die selection

Breech Lock Bushings

Breech lock bushings fit all Lee Breech Lock presses. Allows instant, accurate die changes.

90600 2-Pk 11.98



Decapping Die

An absolute must for those who clean cases before reloading. No cleaning or lubing needed when using this die. Tough, almost unbreakable decapper easily removes crimped in primers. Fits cases up to .560" in diameter; up to 3.125" long.

90292 14.98

REPLACEMENT DECAPPER
UNGUIDED 90783 2.50
GUIDED 4.00

For smooth operation and less decapper bending or breaking, order caliber specific guided decapper.

| | | | |
|-------|------------------|-------|-----------|
| 91574 | 17 CAL-204 RUGER | 91580 | 30 CAL |
| 91576 | 22 CAL | 91581 | 34-35 CAL |
| 91577 | 6mm-25 CAL | 91583 | 40 CAL |
| 91578 | 27 CAL -7mm | 91584 | 45 CAL |



Universal Case Expanding Die

Gently flares the case mouth to accept cast bullets without shaving. Works great to prevent damaging the moly and low friction coatings found on today's high performance jacketed bullets. Includes neck plugs for .22 cal through .45 cal. Works on everything from the 22 Hornet to the largest Ultra Mag. Costs so little and works so well you can't afford to be without one.

90798 16.98

BULGE BUSTER KIT shown mounted to Breech Lock Reloader Press (90045). Sold separately, pg. 18



Utilize all your brass by removing annoying bulge rings

Lee Bulge Buster Kit

Assure your mixed brass is bulge free with the Bulge Buster Kit and appropriate Lee Carbide Factory Crimp Die. This push through die adapter will quickly remove the annoying bulge rings that shell holder constrained dies simply can't reach. The Bulge Buster Kit includes extension sleeve, push through punch, catch container and complete instructions. And it's fast — you can reprocess your cases as quickly as you can handle them. CARBIDE FACTORY CRIMP DIES, SEE PAGE 7

Bulge Buster Kit 90487 19.98

WITH THE LEE FACTORY CRIMP DIE, THE BULGE BUSTER WILL REPAIR ALL THESE RIMLESS CASES

| | | | |
|-------|---------|-------|------------|
| 90867 | 380 ACP | 90864 | 45 ACP |
| 90862 | 10 mm | 90864 | 45 GAP |
| 90862 | 40 S&W | 90864 | 45 Win Mag |
| 90416 | 41 AE | | |



Push through Punch Extension Sleeve Catch Container



1 · 2 · 3 · 4 · 5 · 7 · 8
9 · 10 · 11 · 19

SET OF SHELLHOLDERS

Eleven of the most popular sizes fit over 115 different cartridges. The chart (left) is included with each shell holder set.

UNIVERSAL SHELL HOLDER SET
90197 47.00

WORKS WITH ALL BRANDS OF PRESSES

NOT PURCHASING LEE DIES?

YOU'LL STILL NEED A SHELL HOLDER
ONLY LEE OFFERS A **FREE SHELL HOLDER**
WITH EVERY PISTOL DIE SET PURCHASE

[OTHERS CHARGE \$14.50 FOR THIS NECESSARY PART!]

Lee Die Boxes

Perfect storage for dies. Made from tough, durable plastic.

| | | |
|----------------|-------|------|
| SINGLE DIE BOX | 90616 | 2.98 |
| ROUND DIE BOX | 90535 | 6.50 |
| FLAT 3-DIE BOX | 90791 | 4.98 |
| FLAT 4-DIE BOX | 90422 | 5.98 |

Holds dies with Breech Lock Quick Change insert installed.

Round Die Box lets you store dies installed in 3-hole turret.



LEE OFFERS THE MOST COMPLETE DIE SETS

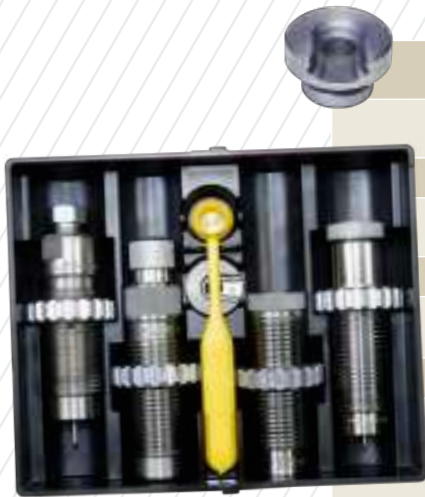

FREE SHELL HOLDER
SOME CHARGE OVER \$14.50 FOR THIS NECESSARY PART

FREE COMPREHENSIVE LOAD DATA
PRICELESS ON SOME CARTRIDGES

FREE POWDER DIPPER

EASIEST TO ADJUST DIES
WITH FINGER TIGHTEN LOCK RINGS

BUILT-IN STUCK CASE REMOVER

CASE SIZING LUBRICANT
INCLUDED WITH PACESETTER & ULTIMATE DIE SETS

TIGHTEST TOLERANCE IN THE INDUSTRY

EXCLUSIVE FEATURE
PACESETTER AND ULTIMATE DIE SETS
INCLUDE FACTORY CRIMP DIE;
THIS DIE FIRMLY CRIMPS BULLET IN PLACE
AND APPLIES A FACTORY-STYLE CRIMP



NO TOOL
REQUIRED
FINGER
ADJUSTABLE
BULLET SEATING



BUILT-IN
STUCK CASE REMOVER
CASE SIZING LUBRICANT

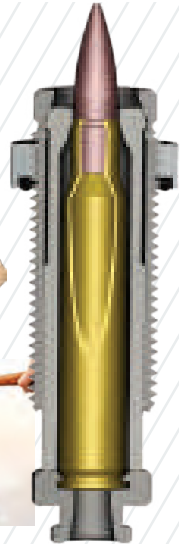

EXCLUSIVE
FACTORY
CRIMP DIE

Lee Pacesetter & RGB Series Dies

FOR PRODUCING
FACTORY-DIMENSIONED
AMMO THAT RELIABLY
FITS AND FEEDS
IN ANY GUN

First choice for semi-auto actions. Full-length sizing is a must if you are reloading for more than one firearm or reloading cases that were fired in other firearms. Pacesetter 3-die sets include the LEE FACTORY CRIMP DIE.



RGB DIES
see page 12



PACESETTER DIES page 12



COLLET
NECKSIZING
DIES
see page 13

Lee Collet Necksizing Dies

For best accuracy, longest case life and no resizing lubricant. Only the neck of the case is resized. The body is untouched—retains perfect fit to your gun's chamber. Cases should have been fired in your firearm only. Benchrest shooters' first choice; there is no other die that can produce a more accurate cartridge.

IF YOU INTEND TO RELOAD CASES FIRED IN OTHER GUNS
OR YOU ARE RELOADING FOR MORE THAN ONE GUN,
SELECT THE

Lee Ultimate Rifle Die Set

The Ultimate Set includes a full length resizing die that allows you to restore any case to factory original dimensions so that you can fire form in your gun and then reload using the superior Collet neck sizing die. Ultimate Rifle Die Sets include the LEE FACTORY CRIMP DIE.



ULTIMATE RIFLE DIE SET see page 13

FACTORY CRIMP DIE



THE LEE FACTORY CRIMP DIE is the only effective way to crimp bottleneck rifle cartridges. Our Factory Crimp Die should be used on all loads used for hunting. Applying a factory crimp will always improve the utility of the cartridge, and in most cases, will also improve the accuracy.

The Lee Factory Crimp die crimps the bullet in place more firmly than any other tool. It is impossible to buckle the case as with regular roll crimp dies. Trim length is not critical. Tests demonstrate that even bullets which have no cannelure will shoot more accurately if crimped in place with the Lee Factory Crimp Die.

Factory ammunition is often more accurate and better able to withstand rough handling because the bullet is firmly crimped in place. A firm crimp improves accuracy because pressure must build to a higher level before the bullet begins to move. This higher start pressure insures a more uniform pressure curve and less velocity variation. Even powder selection is less critical. Until now, handloaders seated the bullet to touch the rifling to achieve similar results. This is not always possible nor desirable. The Lee Factory Crimp Die is included at no

extra charge with Lee PaceSetter 3-Die Sets and Ultimate Rifle Die Sets. It's just another added value that only Lee Dies offer.

LEE FACTORY CRIMP DIE 15.98

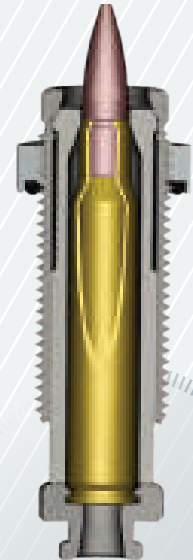

NO CRIMP GROOVE REQUIRED - EVEN WITH JACKETED BULLETS

NOT PURCHASING LEE DIES? YOU'LL STILL NEED A SHELL HOLDER

MOST LEE RIFLE DIE SETS INCLUDE A **FREE SHELL HOLDER**. Others charge \$14.50 for this necessary part!

SET OF SHELLHOLDERS Eleven of the most popular sizes fit over 115 different cartridges. Chart below included with each shell holder set.

1 · 2 · 3 · 4 · 5 · 7 · 8 · 9 · 10 · 11 · 19



UNIVERSAL SHELL HOLDER SET

90197 47.00

Works with all brands of presses

| SHELL HOLDER | FOR PRESSES 5.98 |
|--------------|------------------|
|--------------|------------------|

| | |
|-----|-------|
| #1 | 90518 |
| #2 | 90519 |
| #3 | 90520 |
| #4 | 90521 |
| #5 | 90522 |
| #6 | 90523 |
| #7 | 90524 |
| #8 | 90525 |
| #9 | 90526 |
| #10 | 90527 |
| #11 | 90528 |
| #12 | 90529 |
| #13 | 90199 |
| #14 | 90001 |
| #15 | 90002 |
| #16 | 90003 |
| #17 | 91497 |
| #18 | 91498 |
| #19 | 90004 |
| #20 | 91499 |
| #21 | 90599 |
| #22 | 91500 |
| #23 | 91501 |
| #24 | 91502 |
| #25 | 91503 |

| HOLDER | RIFLE | HOLDER | RIFLE | HOLDER | RIFLE | HOLDER | RIFLE | HOLDER | PISTOL |
|--------|--------------------|--------|----------------------|--------|----------------------|--------|------------------|--------|----------------------|
| 20 | 17 Hornet | 2 | 250 Savage | 12 | 7.62mm x 39 | 2 | 35 Remington | 7 | 32 ACP |
| 4 | 17 Remington | 3 | 25/35 | 16 | 7.62x54 Russian | 5 | 35 Winchester | 4 | 32 Colt N.P. |
| 4 | 204 Ruger | 4 | 25/45 Sharps | 3 | 30 Herrett | 2 | 35 Whelen | 4 | 380 Auto |
| 4 | 22 TCM | 2 | 257 Roberts | 3 | 30/30 Win. (30 WCF) | 5 | 350 Rem. Mag. | 19 | 9mm LUGER |
| 20 | 22 Hornet | 5 | 257 Weatherby | 2 | 300 Savage | 3 | 356 Winchester | 3 | 38 S & W |
| 20 | 22 K Hornet | 2 | 6mm Creedmoor | 16 | 30/378 | 2 | 358 Winchester | 1 | 38 Colt N.P. |
| 3 | 22 Savage | 2 | 6.5mm Creedmoor | 21 | 30 Remington | 5 | 358 Norma Magnum | 5 | 38 Super Auto |
| 2 | 22 BR | 2 | 6.5mm 06 | 2 | 308 Win. (7.62 NATO) | 3 | 375 Winchester | 19 | 38 Super Auto |
| 6 | 218 Bee | 2 | 6.5mm x 57 | 4 | 300 AAC Blackout | 5 | 375 H & H | 19 | 38 ACP |
| 12 | 22 PPC | 3 | 6.5 x 55 Mauser | 5 | 30/40 Krag (30 U.S.) | 5 | 375 Weatherby | 1 | 38 Short Colt |
| 3 | 219 Zipper | 10 | 6.5 Jap | 2 | 30/06 Springfield | 5 | 375 Ultra Magnum | 1 | 38 Long Colt |
| 10 | 220 Swift | 5 | 6.5 Rem. Magnum | 5 | 300 H & H | 5 | 375 Ruger | 1 | 38 Special - 357 Mag |
| 4 | 221 Fireball | 2 | 6.5 Carcano | 5 | 300 Weatherby | 14 | 38/40 Win. | 19 | 357 Sig |
| 4 | 222 Remington | 12 | 6.5 Grendel | 5 | 300 Win Magnum | 3 | 38/55 Winchester | 2 | 357 Auto Magnum |
| 4 | 222 Rem. Magnum | 5 | 264 Win. Magnum | 5 | 300 Ultra Magnum | 8 | 40/82 Winchester | 19 | 40 S&W - 10mm Auto |
| 4 | 223 (5.56mm) | 5 | 26 Nosler | 5 | 300 Win S Magnum | 5 | 416 Remington | 1 | 41 Long Colt |
| 5 | 223 WSSM | 21 | 6.8 SPC | 5 | 308 Norma Magnum | 25 | 416 Rigby | 19 | 41 Action Express |
| 2 | 224 Clark (22/257) | 2 | 270 Winchester | 5 | 303 British | 18 | 43 Mauser | 9 | 41 Magnum |
| 21 | 224 Valkyrie | 5 | 270 Weatherby | 2 | 7.7 Japanese | 17 | 43 Spanish | 19 | 41 Magnum |
| 10 | 225 Winchester | 5 | 270 Win S Mag | 3 | 32 Win. Sp'1 | 14 | 44/40 | 11 | 44 S&W Spl - 44 Mag |
| 2 | 22/250 | 2 | 280 Remington | 3 | 32 Win. S.L. | 11 | 444 Marlin | 11 | 44 S & W Russian |
| 2 | 240 Weatherby | 2 | 7mm/08 | 6 | 32/20 (32 W.C.F.) | 8 | 45/70 Gov't | 2 | 44 Auto Mag. |
| 2 | 243 Win. | 2 | 7mm BR | 3 | 32/40 Springfield | 2 | 450 Bushmaster | 2 | 45 Auto |
| 5 | 243 WSSM | 4 | 7mm TCU | 2 | 8 x 57 Mauser | 5 | 458 Win. Magnum | 11+14 | 45 Colt |
| 2 | 6mm Remington | 3 | 7 x 30 Waters | 2 | 8mm 06 | | | | |
| 2 | 244 Remington | 2 & 10 | 7 x 57mm Mauser | 2 | 8mm Man. Schoe. | 15 | 5.7 x 28 | 14 | 45 Schofield |
| 2 | 6mm Int'l | 5 | 7 x 61 Sharpe & Hart | 5 | 8mm Rem. Magnum | 1 | 22 Rem. Jet | 11 | 454 Casull |
| 2 | 6mm/284 | 5 | 7mm Rem. Magnum | 17 | 8mm Lebel | 15 | 25 ACP | 14 | 460 S&W |
| 2 | 6mm/06 | 5 | 7mm Win S Mag | 16 | 8x56R Hungarian | 1 | 256 Win. Magnum | 5 | 455 Webley |
| 12 | 6 PPC | 5 | 7mm Weatherby | 8 | 33 Winchester | 19 | 30 Luger | 13 | 45 Auto Rim |
| 4 | 6 x 47 (6mm/222M) | 5 | 7mm Ultra Mag | 25 | 338 Lapua | 19 | 30 Mauser | 3 | 45 Win. Magnum |
| 2 | 25/284 | 2 | 284 Winchester | 5 | 338 Win. Magnum | 4 | 32 Short Colt | 5+16 | 480 Ruger |
| 5 | 25/303 | 3 | 7.5mm Schmidt-Rubin | 5 | 338 Ultra Magnum | 4 | 32 Long Colt | 5 | 475 Linebaugh |
| 2 | 25/06 | 7 | 30 M.1 Carbine | 5 | 340 Weatherby | 4 | 32 S & W | | |
| 6 | 25/20 Winchester | 3 | 7.65x53 Arg. Mauser | 8 | 348 Win. | 4 | 32 S & W Long | 16 | 500 S&W |

BEST

INTERNAL FINISH IN THE INDUSTRY

ALL LEE DIES ARE MACHINE HONED TO THE SMOOTHEST POSSIBLE FINISH
 Don't confuse this with the surface polish that's used by most manufacturers. A polish simply makes a shiny surface. It's like trying to sand wood without backing under the sandpaper. The surface in Lee dies is progressively honed to a fine finish with no waves or ripples.

INCLUDES

- FULL LENGTH SIZER
- EASY ADJUST DEAD LENGTH BULLET SEATING DIE
- FACTORY CRIMP DIE
- BUILT IN STUCK CASE REMOVER
- RESIZING LUBRICANT PACKET
- EASY X EXPANDER
- SHELL HOLDER
- POWDER DIPPER
- LOAD DATA & INSTRUCTIONS



INCLUDES THE EXCLUSIVE LEE FACTORY CRIMP DIE

Lee PaceSetter™ 3-Die Set

THESE DIES ARE YOUR BEST BUY!
 Lee PaceSetter 3-Die sets include the exclusive Lee Factory Crimp™ Die to produce factory-like ammunition with improved utility and accuracy. The die set also includes an easy adjust dead length bullet seater, shell holder, powder dipper, load data—and all are packed in the nicest storage box ever designed. The extras represent a \$32.00 value. Most are unavailable at any price from other suppliers.

These are the most copied dies in the world. Each and every die comes with a written lifetime warranty, 2-year guarantee and *guarantee of accuracy or your money back!*

- LEE PACESETTER 3-DIE SET 42.98
- LEE PACESETTER 2-DIE SET 42.98

The same features as our PaceSetter 3-die set, just in very limited production. Does not include Factory crimp die; rather, a bullet seat and crimp die.

COLLET TYPE DECAPPER CLAMP. HOLDS EASY X EXPANDER PERFECTLY CENTERED IN THE DIE. ALLOWS DECAPPER TO SLIDE HARMLESSLY UP PREVENTING DECAPPER BREAKAGE IF AN OBSTRUCTION IS ENCOUNTERED

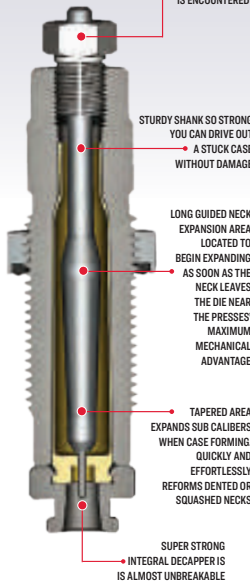

STURDY SHANK SO STRONG YOU CAN DRIVE OUT A STUCK CASE WITHOUT DAMAGE

LONG GUIDED NECK EXPANSION AREA LOCATED TO BEGIN EXPANDING AS SOON AS THE NECK LEAVES THE DIE NEAR THE PRESSES' MAXIMUM MECHANICAL ADVANTAGE

TAPERED AREA EXPANDS SUB CALIBERS WHEN CASE FORMING. QUICKLY AND EFFORTLESSLY REFORMS DENTED OR SQUASHED NECKS

SUPER STRONG INTEGRAL DECAPPER IS ALMOST UNBREAKABLE

LEE RIFLE DIES FEATURE
 THE LEE **EasyX** EXPANDER



Lee Resizing Lubricant

ANOTHER FIRST BY LEE. We purchased the finest automotive deep draw lubricant and had it custom packaged exclusively for us. Lee lube is pleasant to handle and you can thin it with water. Non-sticky, nonallergenic. Very little is needed; it goes a long way. Eliminates stuck and dented cases and makes sizing less work.

- 2 OZ. TUBE 90006 4.98

REALLY GREAT BUY!



RGB Dies Compare to other brands costing twice as much and you'll recognize what a fantastic bargain they are. We offer these only to show that when you buy Lee Dies — without all of the extras Lee customers have come to expect — the price is significantly lower, yet the quality is the best. Our tolerance is 50% less than the advertised amount of a popular and expensive brand. We guarantee these dies to be better than any other brand. If for any reason you're not 100% satisfied—just return them to the factory with your sales slip and pay the difference of what you paid and the manufacturer's catalog list price of the dies you want. We will ship them to you with our thanks for trying ours.

These dies are a **Really Great Buy**. They cost less, because like other die makers, we left out \$32.00 worth of extras which are included in our PaceSetter™ dies. Do yourself a favor and check our PaceSetter dies.

RGB Series Dies only **27.98**



Spline Drive Bushings

Breech lock quick change bushing with integral lock collar provides unmatched precision and convenience when adjusting dies. Split clamp positively locks die into position.

- 90063 2-Pk 16.00

Buy more for greater savings



- 90042 3-Pk 21.00



- 90095 4-Pk 25.00

COLOR CODED FOR QUICK, POSITIVE DIE SELECTION

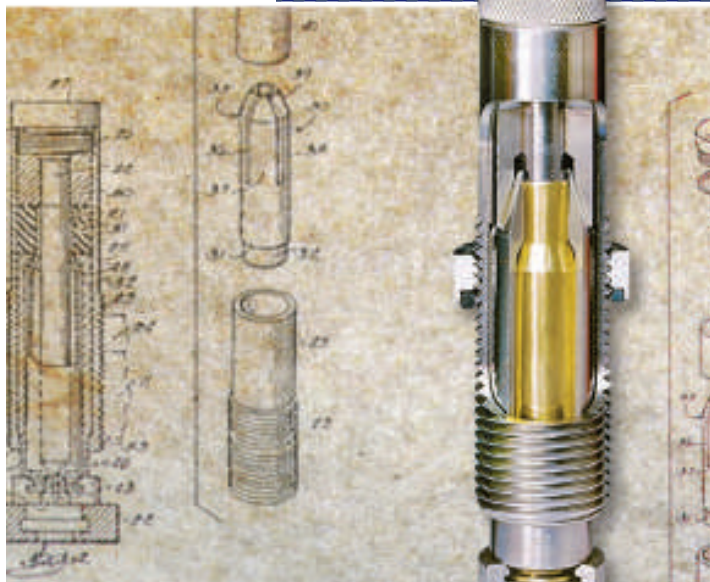

GUARANTEED TO LOAD THE MOST ACCURATE AMMUNITION OR YOUR MONEY BACK

- NO LUBRICATION REQUIRED
- GUARANTEED ACCURACY
- EXTENDS CASE LIFE 10X
- FASTEST TO USE
- NO CLEANING OR LUBING REQUIRED

Lee Collet Dies

There is no loading system that will load more accurate ammunition than Lee Collet Dies. We guarantee it in writing with every set. No one but Lee has ever dared make a guarantee like this — ***Smallest group size or your money back.*** A collet squeezes the case neck against a precision mandrel for a perfect bullet fit with minimum run-out. No case lube is needed. Cases

last ten times longer, so the savings on only 35 cases will pay for the dies. Maximum accuracy is usually achieved by seating the bullet out far enough to touch or almost touch the rifling. This provides the shot start pressure normally supplied by the crimp. That's why a dead length bullet seater is included to complete the most accurate

reloading system ever made. These dies size only the neck to preserve the perfect fit of fire forming. Only reload cases that have been fired in your gun. Not recommended for autoloaders, slide or lever action guns. See list of sizes on pages 14-15.

Lee Collet Die for neck sizing **43.98**

DIE SETS INCLUDE: COLLET NECK SIZING DIE, DEAD LENGTH BULLET SEATING DIE, SHELL HOLDER, POWDER DIPPER, CHARGE TABLE AND STORAGE BOX. MOST CALIBERS NOT LISTED CAN BE CUSTOM MADE. SEE WEB FOR DETAILS: leeprecision.com/custom-collet-neck-sizing-die-set.html

Lee Ultimate Rifle Die Set

Choose this die set for maximum versatility. The set features a full length-resizing die to return brass to factory new dimensions, perfect for reloading brass fired in other guns. The Collet Necksizing die is used on your fire formed brass giving you best possible accuracy. No case lube required and cases last almost forever. The Easy Adjust Dead Length Bullet seating die foolproofs the bullet seating adjustment, and assures perfect seating depth every time. The Factory Crimp Die provides a secure crimp on bullets with or without a crimp groove. In most cases, it helps accuracy by providing a uniform higher start pressure and gives the finished cartridge factory-like accuracy and dependability.

The set is complete with shell holder, powder measure and famous Lee load data featuring all common brands of powder organized in an easy to read logical format.

In addition to best accuracy, you get these benefits

- NO CASE LUBRICATION REQUIRED WITH COLLET DIE
- REDUCED OR ELIMINATES CASE TRIMMING
- TEN TIMES INCREASED CASE LIFE
- UNMATCHED SPEED AND CONVENIENCE
- MINIMUM BULLET RUNOUT
- MOST UNIFORM NECK TENSION

LEE ULTIMATE RIFLE DIE SET **69.00**

INCLUDES COMPLETE COLLET DIE SET PLUS FACTORY CRIMP DIE, FULL LENGTH RESIZING DIE & RESIZING LUBRICANT SAMPLE.



LEE COLLET DIES ACCURACY CONTRIBUTES TO WORLD RECORD



While competing in a regularly sanctioned 1000 Yard Match on July 25th, 1993, Robert Frey established a new 1000 yard world record. We're honored he used the Lee Collet Die to load his record setting ammunition.

World record breaker Robert Frey commented: "The Lee Collet Neck Sizing Die enables me to get top accuracy from my rifles (match and hunting). The design principle of sizing the case neck to a mandrel is unmatched for accuracy potential by any other dies. It is one of the best ways to make all of my rifles shoot their tightest groups."

FREE SHELLHOLDER INCLUDED WHERE SHOWN

The price of Lee Dies include a FREE shell holder of the proper size. Some manufacturers charge \$14.50 extra for this necessary part.



| | RGB DIES P.12 | PACESETTER 3-DIE SET P.12 | PACESETTER 2-DIE SET P.12 | PACESETTER VERY LTD. P.12 PRODUCTION | COLLET DIE SET P.13 | ULTIMATE RIFLE DIE SET P.13 | COLLET NECK SIZING DIE P.13 | .002 UNDERSIZE COLLET MANDREL | FACTORY CRIMP DIE P.11 | CASE LENGTH GAUGE P.29 | UNIVERSAL SHELLHOLDER P.11 | PRIMING TOOL SHELLHOLDER P.31 | QUICK TRIM DIE BODY P.28 |
|-------------------------|-----------------|-----------------------------|-----------------------------|----------------------------------------|-----------------------|-------------------------------|-------------------------------|-------------------------------|--------------------------|--------------------------|------------------------------|---------------------------------|----------------------------|
| | 27.98 | 42.98 | 42.98 | 47.98 | 43.98 | 69.00 | 27.98 | 5.00 | 15.98 – 20.00 | 7.50 – 12.00 | 5.98 | 2.98 | 15.00 – 20.00 |
| 17 Hornet | | 90096 | | | | | | | 90605 | N/A | 91499 | 90020 | 90611 |
| 17 Remington | | | 90770 | | 90804 | | 91000 | | 91571 | N/A | 90521 | 90204 | 90435 |
| 204 Ruger | | 90417 | | | 90734 | | 91001 | | 90567 | N/A | 90521 | 90204 | 90439 |
| 22 Hornet | | 90500 | | | 90705 | | 91002 | | 90829 | 90111 | 91499 | 90020 | 90354 |
| 218 Bee | | 90753 | | | | | | | 90830 | 90225 | 90523 | 90206 | 91350 |
| 221 Fireball | | 90549 | | | | | | | 90829 | 90112 | 90521 | 90204 | 91364 |
| 222 Remington | 90870 | 90501 | | | 90706 | | 91003 | | 90816 | 90113 | 90521 | 90204 | 90340 |
| 223 Remington | 90871 | 90502 | | | 90707 | 90694 | 90954 | 90602 | 90817 | 90114 | 90521 | 90204 | 90179 |
| 223 Ack. Imp. | | | | 90981~ | 90707 | | 90954 | 90602 | 90817 | 90114 | 90521 | 90204 | 90179 |
| 25-45 Sharps | | | | 90475*~ | | | | | 91107 | | 90521 | 90204 | |
| 22/250 | 90872 | 90503 | | | 90708 | 90739 | 90955 | 90602 | 90818 | 90116 | 90519 | 90202 | 90284 |
| 22/250 Ack. Imp. | | | | 90980~ | 90708 | | 90955 | 90602 | 90818 | 90116 | 90519 | 90202 | 90284 |
| 220 Swift | | 90542 | | | 90702 | | 91004 | | 90831 | 90118 | 90527 | 90210 | 91370 |
| 223 WSSM | | | 90446 | | | | | | | 90673 | 90522 | 90205 | 91358 |
| 243 Winchester | 90873 | 90504 | | | 90709 | 90556 | 90956 | 90007 | 90819 | 90119 | 90519 | 90202 | 90320 |
| 6mm Creedmoor | | 90482 | | | 90759 | | 91005 | 90007 | 91488 | 91340 | 90519 | 90202 | 90658 |
| 6mm Rem /244 Rem | | 90540 | | | 90710 | | 91006 | 90007 | 90832 | 90120 | 90519 | 90202 | 90434 |
| 243 WSSM | | | 90990 | | | | | | 90187 | 90389 | 90522 | 90205 | 91341 |
| 25/20 WCF | | 90750 | | | | | | | 90833 | 90121 | 90523 | 90206 | 91385 |
| 25/35 | | | 90778 | | | | | | 91235 | 91306 | 90520 | 90203 | |
| 250 Savage/250-3000 | | 90550 | | | | | | | 90834 | 90122 | 90519 | 90202 | 91374 |
| 257 Roberts | | 90551 | | | 90703 | | 91007 | | 90835 | 90123 | 90519 | 90202 | 91357 |
| 257 Ack. Imp. | | | | 90988~ | 90703 | | 91007 | | 90835 | 90123 | 90519 | 90202 | 91357 |
| 260 Remington | | 90298 | | | 90974 | | 91008 | 90069 | 90977 | 90993 | 90519 | 90202 | 90399 |
| 25/06 Rem | | 90536 | | | 90711 | | 90957 | | 90836 | 90124 | 90519 | 90202 | 90334 |
| 25 WSSM | | | 90413 | | | | | | | 90221 | 90522 | 90205 | |
| 264 Win Mag | | | 90774 | | | | | | 91247 | 91308 | 90522 | 90205 | |
| 26 Nosler | | 90081 | | | | | | | 91163 | 91307 | 90522 | 90205 | 90637 |
| 6.5 Carcano | | | 90749 | | | | | | 91229 | 90043 | 90519 | 90202 | 91353 |
| 6.5 Japanese | | | 90730 | | | | | | | 91331 | 90527 | 90210 | |
| 6.5 x 55 Swedish Mauser | 90874 | 90627 | | | 90712 | | 91009 | 90069 | 90837 | 90126 | 90520 | 90203 | 90337 |
| 6.5 Creedmoor | 91556 | | | | | 90939 | 91012 | 90069 | 90704 | 90814 | 90519 | 90202 | 90812 |
| 6.5 PRC | | | | 90662 | | | | | 91492 | 91533 | 90522 | 90205 | 91348 |
| 6.5/300 Win Short Mag | | | | 90985 | | | | | | | 90522 | 90205 | |
| 6mm ARC | | | | 91562*~ | 91563* | | | | 91664 | | 90529 | 90212 | 91665 |
| 6.5 Grendel | | 90557 | | | 91606 | | | | 90596 | 91278 | 90529 | 90212 | 90763 |
| 270 Win Short Mag | | 90572 | | | | | | | 90962 | 90117 | 90522 | 90205 | 90393 |
| 270 Winchester | 90875 | 90505 | | | 90713 | 90593 | 90958 | 90496 | 90820 | 90128 | 90519 | 90202 | 90229 |
| 224 Valkyrie | | 90066 | | | | | | | 91487 | 91339 | 90599 | 90031 | 90868 |
| 6.8 Rem SPC | | 90427 | | | | | | | 90735 | 90189 | 90599 | 90031 | 90397 |
| 7/30 Waters | | 90748 | | | | | | | 90838 | 91335 | 90520 | 90203 | |
| 7 x 57 Mauser | | 90541 | | | 90714 | | 91010 | 90631 | 90839 | 90130 | 90519 | 90202 | 90489 |
| 7 x 64 Brenneke | | 90771 | | | | | | | 90821 | 90236 | 90527 | 90210 | 91386 |
| 7mm/08 | | 90537 | | | 90723 | | 91011 | 90631 | 90840 | 90167 | 90519 | 90202 | 90343 |
| 7mm Express/280 Rem | | 90552 | | | 90724 | | 91013 | 90631 | 90841 | 90166 | 90519 | 90202 | 90412 |
| 280 Ack. Imp. | | | | 90989~ | 90724 | | 91013 | 90131 | 90841 | 90166 | 90519 | 90202 | 91375 |
| 7mm Win Short Mag | | | 90573 | | | | | | 91271 | 90314 | 90522 | 90205 | |
| 7mm Rem Mag | 90876 | 90538 | | | 90720 | 90679 | 91014 | 90631 | 90821 | 90131 | 90522 | 90205 | 90297 |
| 7mm STW | | 90678 | | | | | | | 90869 | 91332 | 90522 | 90205 | |
| 7mm Ultra Mag | | 90979 | | | | | | | 90869 | 91333 | 90522 | 90205 | |
| 284 Winchester | | | 90777 | | | | | | 91249 | 90129 | 90519 | 90202 | 91362 |
| 7.35 Carcano | | | 90766 | | | | | | 91269 | 91293 | 90519 | 90202 | |
| 7.5 x 55 Swiss | | 90767 | | | 90186 | | 91015 | 90480 | 90184 | 90132 | 90520 | 90203 | 90419 |
| 7.5x54 French MAS | | 90246 | | | | | | | 90842 | 90051 | 90520 | 90203 | 91359 |
| 7.62 x 39 Russian | 90877 | 90565 | | | 90701 | | 91016 | | 90827 | 90133 | 90529 | 90212 | 90345 |
| 7.62 x 54 Russian | | 90731 | | | 91607 | | | | 90842 | 90147 | 90003 | 90200 | 90342 |
| 300 AAC Blackout | | 90575 | | | 90772 | | 91017 | | 90590 | 90443 | 90521 | 90204 | 90689 |

* THESE DIES DO NOT INCLUDE LOAD DATA

~ 3 DIE SET WITH FACTORY CRIMP DIE



FREE SHELLHOLDER INCLUDED WHERE SHOWN

| | RGB DIES P.12 | PACESSETTER 3-DIE SET P.12 | PACESSETTER 2-DIE SET P.12 | PACESSETTER VERY LTD. P.12 PRODUCTION | COLLET DIE SET P.13 | ULTIMATE RIFLE DIE SET P.13 | COLLET NECK SIZING DIE P.13 | .002 UNDERSIZE COLLET MANDREL | FACTORY CRIMP DIE P.9, 11 | CASE LENGTH GAUGE P.29 | UNIVERSAL SHELLHOLDER P.11 | PRIMING TOOL SHELLHOLDER P.31 | QUICK TRIM DIE BODY P.28 | 1 1/4-12 THREAD SERIES FACTORY CRIMP DIES P.20 | 1 1/4-12 THREAD SERIES COLLET DIES P.20 | 1 1/4-12 THREAD SERIES P.20 | |
|----------------------------------------------------------------|-----------------|------------------------------|--------------------------------------------------------|-----------------------------------------|-----------------------|-------------------------------|-------------------------------|-------------------------------|-----------------------------|--------------------------|------------------------------|---------------------------------|----------------------------|--------------------------------------------------|-------------------------------------------|-------------------------------|--|
| | 27.98 | 42.98 | 42.98 | 47.98 | 43.98 | 69.00 | 27.98 | 5.00 | 15.98-20.00 | 7.50-12.00 | 5.98 | 2.98 | 15.00-20.00 | 50.00 | 125.00 | 125.00 | |
| 300 Ham'R | | | | 91564~ | 91608 | | 91636 | | 91276 | | 90521 | 90204 | 91609 | | | | |
| 30/40 Krag | | 90555 | | | | | | | 90843 | 90137 | 90522 | 90205 | 91354 | | | | |
| 30/30 Win | 90878 | 90506 | | | 90716 | 90693 | 91018 | 90480 | 90822 | 90136 | 90520 | 90203 | 90249 | | | | |
| 30/30 Ack. Imp. | | | | 90982~ | 90716 | | 91018 | | 90822 | 90136 | 90520 | 90203 | 90249 | | | | |
| 303 Savage | | 90756 | | | | | | | 90823 | | 90528 | 90211 | 91383 | | | | |
| 308 Winchester | 90879 | 90507 | | | 90718 | 90695 | 90959 | 90480 | 90823 | 90139 | 90519 | 90202 | 90231 | | | | |
| 300 Win Short Mag | | 90942 | | | 90185 | | 91019 | 90480 | 90331 | 90034 | 90522 | 90205 | 90484 | | | | |
| 300 Savage | | 90545 | | | | | | | 90844 | 90138 | 90519 | 90202 | 91356 | | | | |
| 30/06 | 90880 | 90508 | | | 90715 | 90736 | 90960 | 90480 | 90824 | 90140 | 90519 | 90202 | 90291 | | | | |
| 338/06 | | | | 90987 | | | | | 90849 | | 90519 | 90202 | | | | | |
| 300 Win Mag | 90881 | 90539 | | | 90722 | 90738 | 90961 | 90480 | 90825 | 90142 | 90522 | 90205 | 90441 | | | | |
| 300 H & H | | 90560 | | | 90726 | | 91020 | | 90970 | 90141 | 90522 | 90205 | 90407 | | | | |
| 6.5-300 Weatherby Mag | | | | 90983 | | | | | 91493 | | 90522 | 90205 | | | | | |
| 300 Weatherby Mag | | 90558 | | | 90727 | | 91020 | | 90845 | 90143 | 90522 | 90205 | 90408 | | | | |
| 300 Ultra Mag | | 90698 | | | | | | | 90970 | 90141 | 90522 | 90205 | 91366 | | | | |
| 7.65 Arg Mauser | | 90732 | | | | | | | 90846 | 90134 | 90520 | 90203 | 91382 | | | | |
| 7.7 Jap | | 90733 | | | | | | | 90847 | 90115 | 90519 | 90202 | 91368 | | | | |
| 25-303 | | 90793 | | | | | | | 91491 | | 90522 | 90205 | | | | | |
| 303 British | 90882 | 90547 | | | 90717 | | 91021 | | 90826 | 90144 | 90522 | 90205 | 90325 | | | | |
| 32-40 | | | 90758 | | | | | | 91239 | | 90520 | 90203 | 91376 | | | | |
| 32 Winchester Special | | | 90757 | | | | | | 91227 | 90491 | 90520 | 90203 | | | | | |
| 325 WSM | | | 90923 | | | | | | 91255 | 90222 | 90522 | 90205 | 91344 | | | | |
| 8x56 R Hungarian | | | 90925 | | | | | | 91273 | 90589 | 90003 | 90200 | | | | | |
| 8x57 Mauser | 90883 | 90544 | | | 90719 | | 91022 | | 90848 | 90148 | 90519 | 90202 | 90347 | | | | |
| 8mm Lebel | | | 90768 | | | | | | 91272 | | 91497 | N/A | | | | | |
| 41 Swiss | | | | 90411* | | | | | | | 90525 | 90208 | | | | | |
| 338 Winchester | | 90546 | | | 90721 | | 91023 | | 90849 | 90149 | 90522 | 90205 | 90391 | | | | |
| 338 Ultra Mag | | | 90927 | | | | | | 91257 | 91314 | 90522 | 90205 | | | | | |
| 348 Winchester | | 90760 | | | | | | | 90857 | 91304 | 90525 | 90208 | 91360 | | | | |
| 350 Rem Mag | | | 90776 | | | | | | 91233 | 91315 | 90522 | 90205 | 91377 | | | | |
| 358 Winchester | | 90797 | | | | | | | 90904 | 91318 | 90519 | 90202 | | | | | |
| 35 Remington | | 90543 | | | 90728 | | 91024 | | 90828 | 90150 | 90519 | 90202 | 90403 | | | | |
| 35 Whelen | | | 90752 | | | | | | 91241 | 90972 | 90519 | 90202 | 91355 | | | | |
| 9.3 x 62 Mauser | | 90654 | | | | | | | 90610 | 91299 | 90519 | 90202 | 90614 | | | | |
| 375 Ruger | | 90090 | | | | | | | 90609 | 91285 | 90522 | 90205 | 90613 | | | | |
| 300 PRC | | | | 90224 | | | | | 91494 | | 90522 | 90205 | | | | | |
| 375 H & H | | 90559 | | | 90729 | | 91025 | | 90850 | 90164 | 90522 | 90205 | 90395 | | | | |
| 416 Remington | | 90805 | | | | | | | 90906 | | 90522 | 90205 | | | | | |
| 43 Mauser | | | 90806 | | | | | | | | 91498 | N/A | | | | | |
| 43 Spanish | | | 90765 | | | | | | | | 91497 | N/A | 91367 | | | | |
| 32-20 | | 90751‡ | ‡ THESE DIES DO NOT INCLUDE FACTORY CRIMP DIE | | | | | | | 90421 | 90146 | 90523 | 90206 | 91365 | | | |
| 38-40 | | 90761‡ | | | | | | | 90852 | 91322 | 90001 | 90272 | 91351 | | | | |
| 38-55 | | 90762‡ | | | | | | | 90853 | 90994 | 90520 | 90203 | 91379 | | | | |
| 375 Winchester | | 90563‡ | | | | | | | 90905 | 90165 | 90520 | 90203 | 91371 | | | | |
| 44/40 | | 90564‡ | | | | | | | 90854 | 90168 | 90001 | 90272 | 91369 | | | | |
| 444 Marlin | | 90562‡ | | | | | | | 90855 | 90151 | 90528 | 90211 | 91372 | | | | |
| 45/70 Government | | 90561‡ | 45/70 DIES DO NOT WORK ON HORNADY LEVEREVOLUTION CASES | | | | | | | 90856 | 90152 | 90525 | 90208 | 90458 | | | |
| 450 Bushmaster | | | | 90182 | | | | | 91167 | 91325 | 90519 | 90202 | N/A | | | | |
| 50 Beowulf | | | | 90296* | | 57.98 | | | | 91292 | 90529 | 90212 | | | | | |
| 350 Legend | | 90078 | | | | | | | 90445 | 91567 | 90521 | 90204 | 91561 | | | | |
| 458 Socom | | | | 90409 | | | | | 90815 | 91290 | 90519 | 90202 | N/A | | | | |
| 40/60 | | | | 90214* | | | | | | | 90525 | 90205 | | | | | |
| 458 Win Mag | | 90800‡ | | | | | | | 90969 | 90971 | 90522 | 90205 | 91345 | | | | |
| LARGE SERIES THREADED DIES Use with Classic Cast Press p. 20 | | | | | | | | | | | | | | | | | |
| 338 Lapua | | | 90353 | | | | | | | 90462 | 91503 | 91496 | | 90745 | 90635 | | |
| 416 Barrett* SHELLHOLDER NOT INCLUDED | | | | | | | | | | | 90903^ | | | | | 90252 | |
| 577/450 Martini-Henry* | | | | | | | | | | | 91500 | | | | | 90902 | |
| 577 Snider* | | | | | | | | | | | 91500 | | | | | 90929 | |
| 50 BMG SHELLHOLDER NOT INCLUDED | | | | | | | | | | | 90903^ | | | 90953 | 90747 | 90515 | |

1 1/2-12 to 1 1/4-12 DIE ADAPTER BUSHING
Use these dies in competitor's press
91697 12.00

* THESE DIES DO NOT INCLUDE LOAD DATA ^ 20.00

RELOADING PRESSES LAST A LIFETIME, so buying on what your budget allows makes the most sense. You'll never regret buying a value priced press — you'll always have a need for a simple press for miscellaneous jobs.

SINGLE STATION PRESS OPTIONS

Recommended for new reloaders or those who prefer to batch load



Single Station Presses will load nearly any cartridge. Cartridges are loaded in a batch process—for example, 20 cases are de-primed and sized, charged, then bullets seated. This die changing process is sped up by the Lee Breech Lock Quick-Change System. Rifle case reloading is best accomplished on a single station press. For a beginner, a single station press in a kit is the best value.

| Compatible cartridges | Rounds per hour |
|-------------------------------------------------------------------------------------|-----------------|
| All cartridges up to 460 Weatherby Mag | 50 |
| Breech Lock Challenger Press # 90588 page 19 MSRP \$ 105.00 | |
| Breech Lock Reloader Press # 90045 page 18 MSRP \$ 59.98 | |
| Compatible cartridges | Rounds per hour |
| All cartridges up to 50 BMG | 50 |
| Accepts both 7/8 -14 Threaded Dies and Large Series Threaded Dies 1 1/4 -12 | |
| Classic Cast Press # 90998 MSRP \$ 220.00 see more information on page 20 | |

All Lee Presses feature compound toggle linkages. This permits full length sizing the largest magnum cases with ease. Many feature built-in spent primer catchers, tough powder paint coating and detailed instructions. Under normal use, all our presses will last a lifetime. For those that simply want the best, you can't beat the "Classic Cast."

SINGLE STAGE PRESS KIT OPTIONS

IF YOU ARE JUST GETTING STARTED, YOU CAN SAVE EVEN MORE MONEY BY PURCHASING A KIT



Breech Lock Hand Press Kit #90180 page 18 MSRP \$88.00



Breech Lock Challenger Kit #90030 page 19 MSRP \$210.00



50th Anniversary Kit #90050 page 19 MSRP \$219.00

PROGRESSIVE PRESS OPTIONS

RECOMMENDED FOR ADVANCED HIGH VOLUME USERS

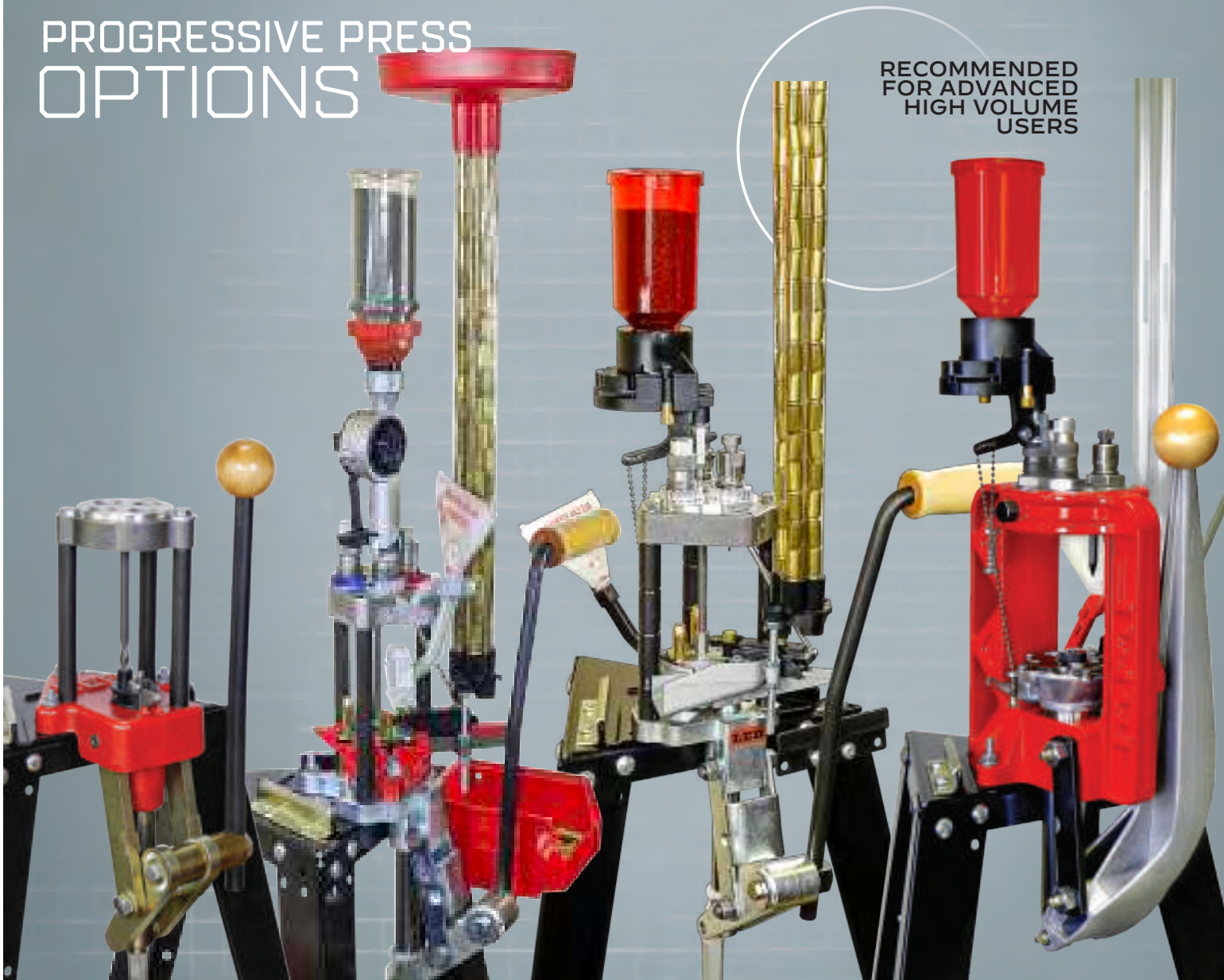

TURRET PRESS

PRO 4000

PRO 1000

LOAD-MASTER

TURRET PRESSES offer single station simplicity with near progressive speed. No need to unscrew dies; the turret advances to the next station automatically. Four pulls of the lever and you have a completed round. Perfect for moderate production of handgun ammunition. Deactivate the Auto-Index feature and you can batch reload the longest rifle cartridges. Twist and exchange the turret, snap in a new shell holder, and you're ready to load your next cartridge.

| Compatible cartridges | Rounds per hour |
|----------------------------------------------------------------|-----------------|
| All cartridges up to 460 Weatherby Mag | 250 |
| Classic Turret Press # 90064 pg 21 MSRP \$ 200.00 | |
| Value Turret Press # 90932 pg. 22 MSRP \$ 140.00 | |

PRO 4000 Designed with the perfect balance of speed and simplicity. This press is so easy to set up and operate: if you have reloaded before, you likely won't even need to look at the instructions. Cartridge changeover can be completed in seconds. Breech Lock quick change feature in all four positions.

You're also going to enjoy using this press for simple case processing like depriming and sizing a batch of cases for tumble cleaning or case trimming. With the auto index deactivated, you can use it as the handiest single station press ever made.

| Compatible cartridges | Rounds per hour |
|---------------------------------------------------------------------------|-----------------|
| 32 S&W Long to 30/06 | 500+ |
| Pro 4000 Kit Full description pg 25 MSRP \$ 330.00 | |
| Auto Breech Lock Pro Press only # 90900 pg 25 MSRP \$ 170.00 | 360 |

DESIGNED FOR VERY HIGH PRODUCTION of handgun cartridges. Add a bullet and pull the lever; other operations are automatic. Select these presses only if you are shooting more than 500 rounds per week.

If loading limited quantities of many different cartridges, a Turret Press or Pro 4000 is your best choice. Changeover from cartridge to cartridge can become involved on the progressive presses.

| Compatible cartridges | Rounds per hour |
|---------------------------------------------------------------|-----------------|
| 32 S&W LONG to 223 Remington | 500+ |
| Pro 1000 FULL DESCRIPTION PAGE 24 MSRP \$ 340.00 | |
| Compatible cartridges | Rounds per hour |
| 32 S&W LONG to 30/06 | 500+ |
| Load-Master FULL DESCRIPTION PAGE 25 MSRP \$ 420.00 | |

COMPACT PRESSES



Shown on optional Bench Plate.
Order #90251

Lee Breech Lock Reloader Press

INCLUDES THE BREECH LOCK SYSTEM

An outstanding value. Exclusive balanced lever that can't drop down to pinch your fingers. Unlimited hand clearance that only a "C" frame can offer. Works equally well with the right or left hand. Even if you already own a press, an extra press is always useful for decapping, bullet seating or bullet sizing.

90045 59.98



BIG GUN INSPIRED BREECH LOCK QUICK CHANGE NOW STANDARD ON ALL LEE SINGLE STATION PRESSES

Switch dies with a 1/6 of a turn rather than fourteen or more turns. Loading with a breech lock equipped press is as convenient as a Turret Press when loading small quantities of ammunition. Interrupted three-start thread assures dies will return and lock into the exact same position. If cost is more important than convenience, you can leave the Breech Lock bushing locked in the press and screw dies in and out like a conventional press.



Change dies instantly with a twist of the wrist

Spline Drive Bushings

Breech lock quick change bushing with integral lock collar provides unmatched precision and convenience when adjusting dies. Split clamp positively locks die into position.

90063 2-Pk 16.00



Buy more for greater savings

90042 3-Pk 21.00



90095 4-Pk 25.00



Color coded for quick, positive die selection

Breech Lock Bushings

Breech lock bushings fit all Lee Breech Lock presses. Allows instant, accurate die changes.

90600 2-Pk. 11.98



Lee Breech Lock Hand Press

Features the Lee Breech Lock System. A full size hand held reloading press, yet the tool weighs only 1 3/4 pounds and costs so little you will want more than one. No matter how much equipment you have, it's great to have a portable hand press. No time is wasted mounting a tool to a work bench. When you're finished—just pack it away.

90685 65.00



BREECH LOCK RAM PRIME

Breech Lock Hand Press Kit

THE PERFECT PORTABLE RELOADING PRESS KIT

Begin reloading at once. No wasted time mounting to a work bench. Pack it all in the box when finished. Great for apartment dwellers or loading at the range. Dies sold separately.

KIT INCLUDES

BREECH LOCK HAND PRESS

RAM PRIME

POWDER FUNNEL

CASE SIZING LUBE

90180 88.00



New, improved Breech Lock Ram Prime

Start priming in seconds, nothing to adjust.

Includes small and large priming assemblies, no tiny parts to fumble with or lose.

Effortless priming in the tightest pockets.

Uses any brand press shell holder.

Safe with all brands of primers.

Works in any Lee Breech Lock press or adapter.

91612 19.98



Lee Ram Prime

Primes on the press up-stroke for a more sensitive feel. Includes small and large priming assemblies; no tiny parts to fumble or lose. Fits all brands of presses. Use on old school presses, where you need to thread in dies.

90106 19.98

*"O" frame ...
most popular
style press
by far*



Breech Lock Challenger Press

The "O" frame press by design is the strongest and most popular style press by far. Large opening and long stroke handles the largest belted magnums with ease. The primer catcher is positive and routes the spent primers directly to the trash can. Priming is a dream with the LEE LEVER PRIME SYSTEM. Best of all, it includes the BREECH LOCK QUICK CHANGE DIE SYSTEM. Change dies instantly with a twist of the wrist; you'll never have to re-adjust your die.

Other features include all steel linkage with adjustable length lever. This same press would cost you more than twice as much from other manufacturers, and that's without all of the Challenger's features.

90588 **105.00**



Primer Arms



LARGE & SMALL SAFETY PRIME
90997 **30.00**

SEE DESCRIPTION PAGE 22



Shown on optional Bench Plate. Order #90251

50TH ANNIVERSARY KIT

A COMPLETE POWDER HANDLING SYSTEM with the most convenient and repeatable PERFECT POWDER MEASURE, plus the LEE SAFETY SCALE, the most sensitive, safest of all powder scales. Fill your cases with the POWDER FUNNEL. \$209.94 value

Case Preparation tools include the LEE VALUE TRIM case trimmer to trim on your reloading press (order cartridge specific trim die separately on pg. 28), and a CUTTER & LOCK STUD to trim your cases. (Order cartridge specific case length gauge separately on pg. 28-29). The LEE CHAMFER TOOL chamfers the inside and outside of the case mouth, and a tube of premium SIZING LUBE is also included. A small and large PRIMER POCKET CLEANING TOOL completes the case preparation package. \$32.90 value.

But that's not all! You get the large and small SAFETY PRIME. Prime with push button convenience and is safe with all brands of primers. Never touch the primer from box to the case. \$30.00 value.

Purchased separately \$242.84 value **90050 219.00**



Shown on optional Bench Plate. Order #90251

BREECH LOCK CHALLENGER KIT

Features the same components as the 50th Anniversary Kit, but we have replaced the Safety Prime with the New Auto-Prime and a set of Auto-Prime shell holders. This kit is for those who prefer to prime off the press. If purchased separately—a \$259.80 value.

90030 210.00

HAVE AN OLD SCHOOL PRESS AND THREAD DIES INTO REMOVABLE, THREADED ADAPTER? MODERNIZE YOUR PRESS WITH THE BREECH LOCK SYSTEM

90512 1¼-12 10.00
90094 1½-12 12.00



PRESS NOW INCLUDES BREECH LOCK ADAPTER

Gives you the ability to quick change dies or remove the adapter to load the mammoth 50 BMG



BAKED POWDER FINISH AND ALL STEEL LINKAGE MAKE THE LEE CLASSIC CAST PRESS THE MOST ATTRACTIVE AND DURABLE PRESS MADE

RIGID CAST IRON FRAME, CAST AND MACHINED WITH PRIDE IN THE USA

LEE CLASSIC CAST PRESS
90998 220.00

- ▶ The industry's largest opening, and longest stroke—handle adjusts to provide least travel of any press.
- ▶ Largest ram, 1½" diameter, supported by over 12 square inches of ram bearing surface.
- ▶ Spent primer disposal direct to trash can with attached tube.
- ▶ Powerful compound linkage with positive travel stop prevents press toggle or "cam over."
- ▶ Rigid cast iron construction in a classic "O" design for maximum strength. Baked powder coating is durable and makes a handsome addition to any reloading bench.
- ▶ Large, flat cored base with 3 mounting holes, mounts solid to any bench.
- ▶ Automatic primer arms with bottom of stroke priming for best feel. Includes both large and small priming arms. No more fumbling with tiny guides and springs when changing primer size.

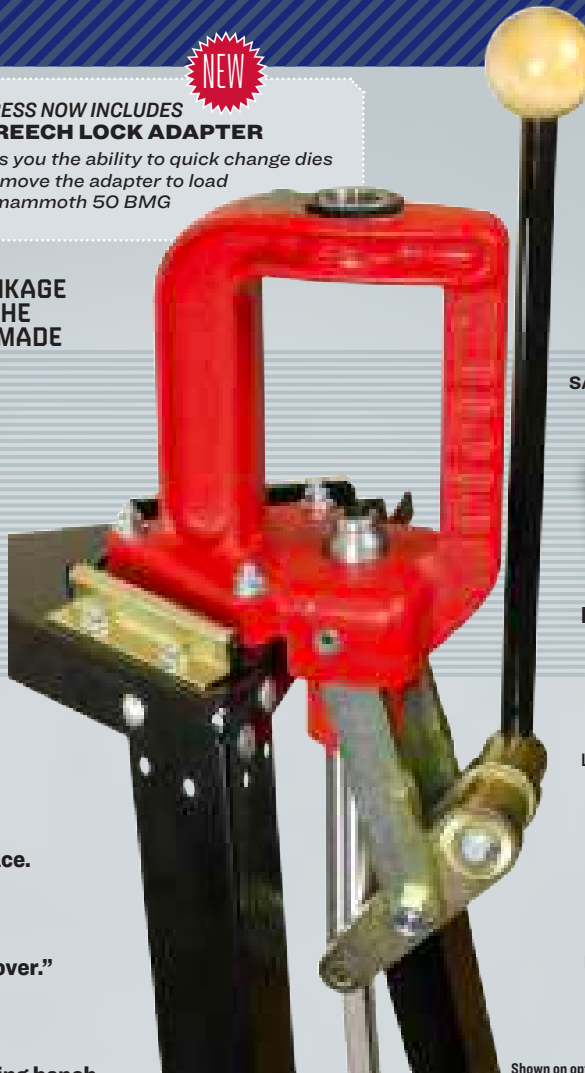

Shown on optional Reloading Stand. Order #90688

- ▶ Designed to work with both standard 7/8-14 and large series 1¼-12 dies. Included Breech Lock adapter to accept standard 7/8-14 dies. Change dies instantly with a quick twist of the wrist.
- ▶ Two-piece ram allows installation of the mammoth 50 BMG shell holder or the shell holder insert for standard press shell holders. Shell holder insert can be rotated to allow primer installation on the right or left side.



LARGE & SMALL SAFETY PRIME
90997 30.00



NEED BUSHINGS?
page 9

CHANGES EASILY FOR LEFT-HANDED USE.



SPENT PRIMERS COLLECTED AND DROPPED INTO FLEXIBLE PLASTIC TUBE FOR EASY EMPTYING.



50 BMG Loading Block
Block dimensions 9" x 8"
High impact, chemical resistant plastic
Holds 72 cases, can also be used to store 7/8 - 14 die sets
Continuous flange surrounds tray for easy lifting.
90632 15.00



1½-12 to 1¼-12 Die Adapter Bushing
Use the Lee 50 BMG and other 1¼ series dies in competitor's 50 BMG large presses. 91697 12.00

LARGE SERIES RELOADING DIES

1¼-12 Thread Series
Factory Crimp Dies 50.00
90953 50 BMG
90745 338 Lapua

1¼-12 Thread Series
Collet Dies 125.00
90747 50 BMG
90635 338 Lapua

1¼-12 Thread Series 125.00
90902 577/450 Martini-Henry *
90929 577 Snider *
90252 416 Barrett *
Shellholder not included
90515 50 BMG
Shellholder not included

*These dies do not include load data



50 BMG Die Set 1¼-12 Thread
90515 125.00



50 BMG Factory Crimp Die
90953 50.00



50 BMG Ram Prime Tool
90901 25.00

CLASSIC CAST 50 BMG PRESS KIT

AT LAST, AN AFFORDABLE WAY TO RELOAD THE MONSTER 50BMG

KIT INCLUDES EVERYTHING YOU NEED TO START RELOADING THE 50

LEE CLASSIC CAST PRESS • SET OF 50 BMG DIES SHELL HOLDER • RAM PRIME TOOL • AND TUBE OF CASE SIZING LUBE

BREECH LOCK ADAPTER KIT also includes shell holder insert, large & small primer arms and breech lock adapter bushing to accept standard 7/8-14 dies so you can load all your smaller cartridges. All this for less than what others charge for dies alone.

50 CALIBER BMG PRESS KIT
90859 370.00



Lee Classic Turret Press

The sturdy iron base shows its Classic Cast roots. The long stroke allows rifle cases over three inches long to be loaded using the automatic index. Deactivate the Auto-Index and cases over 4 inches can be loaded. The rigid cast iron frame supports the ram with over 12 square inches of area. The industry's largest ram is drilled completely through to dispose primers in an attached clear PVC tube. Every primer is caught — guaranteed.

Instant change turrets are the same as the famous Lee Turret Press. The Classic Turret uses the Lee Lever Prime System · LPS and the optional Lee Safety Prime tool makes priming on the press a delight. If you like to own the best, then treat yourself to the Lee Classic Turret. The finest reloading system made.

LEE CLASSIC TURRET PRESS 90064 200.00

Shown on optional Reloading Stand. Order #90688

A MACHINE THAT DOES IT ALL

This press has all the features of the award-winning Turret Press with the quality touches that make this the finest, most convenient press to own. The Classic Turret features the solid steel linkage of the Lee Classic Cast. Your first stroke of the hardwood gripped lever will convince you this is one solid, silky smooth press!



Lee Safety Prime

Makes priming on the press a delight. Never touch the primers from box to shell. Primer flip tray features a CAD designed flipping surface that instantly rights the primers. Change primer size in seconds. Primers are dispensed with a satisfying click of the primer feed trigger.

90997 30.00



POWDER MEASURE RISER FOR SAFETY PRIME
90041
See page 33



GET AN ADDITIONAL TURRET FOR YOUR LEE PRESSES

EXTRA TURRET, 4 HOLE
90269 15.00



SPENT PRIMERS COLLECTED AND DROPPED INTO FLEXIBLE PLASTIC TUBE FOR EASY EMPTYING.

CLASSIC TURRET PRESS KIT

THIS KIT AND A SET OF LEE DIES IS EVERYTHING YOU NEED TO BEGIN RELOADING PISTOL AMMO. The Classic Turret Press is fast and convenient when loading handgun cartridges, with rates in excess of 250 rounds per hour possible.

The kit includes the Auto-Drum powder measure and powder measure riser, perfect for all handgun and rifle cartridges. Large and Small Safety Prime are included making on press priming a delight! Instant Change Turret makes changing calibers a snap. Deactivate the auto-index, and batch load the longest and largest rifle cartridges.

Complementing your press kit are the case conditioning tools to prepare your brass for loading. Includes Cutter, Lock Stud, Chamfer Tool, small and large Primer Pocket Cleaner, and a tube of Lee case sizing lube. Complete it with the cartridge specific Case Length Gauge. Verify your loads with the included Lee Safety powder scale.

Completing the kit is *Modern Reloading Second Edition*, 2019 revision with all new load data covering over 170 cartridges with more than 38,000 loads.
90304 350.00



Shown on optional Bench Plate. Order #90251

NOTE Rifle reloaders require **SHORT** or **LONG CHARGING DIE** | see page 33



Shown on optional Reloading Stand. Order #90688

Low profile steel base with positive through ram primer disposal

Built-in primer disposal tube



VALUE TURRET PRESS

EQUIPPED WITH THE **LEE LEVER PRIME SYSTEM™**

Proven design with compound leverage. No spring in this turret design. The turret is locked into a solid steel ring with big rifle bolt type lugs. Exclusive design puts the lugs on the circumference so there can be no tipping. The linkage is so powerful that the largest magnum cases are sized with ease. Effort required is so small that the usual heavy bench is not essential. The Lee Turret Press has built-in primer disposal tube and a comfortable roller handle. Even if you do not need all of these features, why pay more for anything less?

Power and strength to spare, plus unequalled convenience. The Lee Turret Press is suitable for loading all rifle and pistol cases, but really shines when loading large quantities of handgun ammunition. This is the most convenient press made. Only a true progressive press is faster. Includes the **LEE LEVER PRIME SYSTEM** with large and small primer arms. Works with the Lee Safety Prime.

4 HOLE TURRET PRESS w/Auto Index 90932 140.00



Lee Safety Prime

Makes priming on the press a delight. Never touch the primers from box to shell. Primer flip tray features a CAD designed flipping surface that instantly rights the primers. Change primer size in seconds. Primers are dispensed with a satisfying click of the primer feed trigger.

90997 30.00



POWDER MEASURE RISER FOR SAFETY PRIME 90041
See page 33



GET AN ADDITIONAL TURRET FOR YOUR LEE PRESSES EXTRA TURRET, 4 HOLE 90269 15.00

Lee Value Turret Press Kit

The Value Turret Press, along with the Auto-Drum Powder Measure, produces top quality pistol ammo in a hurry.

A finished round with a few pulls of the lever. Disconnect the Auto-Index and it's large enough to handle monster belted magnum rifle cases. When it's time to change calibers, simply lock in a new turret and begin reloading in seconds. In addition to the Turret Press and Auto Drum Powder Measure, the kit includes the Lee Safety Scale, unmatched for sensitivity, a primer pocket cleaner, cutter and lock stud to trim the cases and a chamfer tool to deburr cases after trimming. Complete the case conditioning tools with the cartridge specific Case Length Gauge (see page 28).

A set of Lee Dies is all that is required to complete this reloading outfit. And all of this at a price that will allow you to pay for your investment in a matter of hours.

VALUE TURRET PRESS KIT 90928 240.00



Shown on optional Bench Plate. Order #90251

NOTE Rifle reloaders require **SHORT** or **LONG CHARGING DIE** | see pg 33

PROGRESSIVE PRESS SHELL PLATES



PRO1000 POSITIVE INDEX SHELL PLATES 20.00

| PRODUCT NO. | PLATE | CARTRIDGES |
|-------------|-------|--------------------------------------------------------|
| 90651 | 1 | 38 SPECIAL, 357 MAG, ETC. |
| 90652 | 2 | 45 ACP, 45 GAP, ETC. |
| 90664 | 3 | 45 WINCHESTER MAGNUM |
| 90653 | 4 | 222, 223, 380 AUTO, 32 S&W LONG, 32 H&R MAGNUM |
| 90976 | 6 | 32/20, 25/20 |
| 90655 | 7 | 30 M1 CARBINE, 32 AUTO |
| 90656 | 9 | 41 MAGNUM |
| 90657 | 11 | 44 SPECIAL, 44 MAGNUM, 45 COLT |
| 90666 | 12 | 7.62X39, PPC, 220 RUSSIAN |
| 90665 | 13 | 45 AUTO RIM |
| 90065 | 14 | 38/40, 44/40, 45 COLT, 460 S&W |
| 90669 | 19 | 40 S&W, 10mm AUTO, 9MM LUGER, 38 SUPER, 38 AUTO, 41 AE |



PRO 4000 SHELL PLATES 25.00

| PRODUCT NO. | PLATE | CARTRIDGES |
|-------------|-------|--------------------------------------------------------|
| 90582 | 1 | 38 SPECIAL, 357 MAG, ETC. |
| 90584 | 2 | 45 ACP, 45 GAP, ETC. |
| 90629 | 3 | 45 WINCHESTER MAGNUM |
| 90630 | 4 | 222, 223, 380 AUTO, 32 S&W LONG, 32 H&R MAG |
| 90647 | 7 | 30 M1 CARBINE, 32 AUTO |
| 90278 | 9 | 41 MAGNUM |
| 90648 | 11 | 44 SPECIAL, 44 MAGNUM, 45 COLT |
| 90414 | 12 | 7.62 x 39 RUSSIAN, 6.5 GRENDL |
| 90649 | 13 | 45 AUTO RIM |
| 90802 | 14 | 38/40, 44/40, 45 COLT, 460 S&W |
| 90659 | 16 | 500 S&W, 7.62X54R |
| 90944 | 19 | 40 S&W, 10MM AUTO, 9MM LUGER, 38 SUPER, 38 AUTO, 41 AE |
| 90941 | 21 | 6.8 SPC, 224 VALKYRIE |



LOAD-MASTER SHELL PLATES 29.98

| PRODUCT NO. | PLATE | CARTRIDGES |
|-------------|-------|---------------------------------------------------------|
| 90907 | 1S | 38 SPECIAL, 357 MAG, ETC. |
| 90908 | 2L | 45 ACP, 30/06, 308, 6.5 CREEDMOOR |
| 90909 | 3L | 30/30, 7x30 WATERS, 7.5 SWISS |
| 90910 | 4S | 222, 223, 380 ACP |
| 90059 | 4A | 32 S&W LONG, 32 H&R MAG., ETC |
| 90911 | 5L | BELTED MAGNUMS 300 MAG 303 BRITISH, 30/40 KRAG, 7MM WSM |
| 90912 | 6S | 32/20, 25/20, ETC. |
| 90913 | 7S | 30 M1 CARBINE, 32 ACP |
| 90914 | 8L | 45/70, 348 WIN, 416 RIGBY |
| 90915 | 9L | 41 MAGNUM |
| 90916 | 10L | 220 SWIFT, 6.5 JAP, 458 SOCOM |
| 90917 | 11L | 44 MAG., 44 SPL., 45 COLT |
| 90918 | 12L | 7.62X39, 6MM PPC, 22 PPC, ETC. |
| 90919 | 14L | 44/40, 38/40, 45 COLT, 460 S&W |
| 90612 | 16L | 500 S&W, 7.62X54R |
| 90920 | 19S | 9MM LUGER, 40 S&W, 38 SUPER, ETC. |
| 90068 | 19L | 10MM AUTO |
| 90884 | 20 | 22 HORNET |
| 90984 | 21L | 6.8 REM SPC, 224 VALKYRIE |

Check shell holder chart on page 31 for further listings.

ACCESSORIES FOR THE PRO 1000 · PRO 4000 · LOAD-MASTER



UNIVERSAL CASE FEED MAGAZINE

90242 **35.00**
Automates case feeding process. Cartridge compatibility listing on leeprecision.com

EXTRA CASE FEEDER TUBES

7 Pk. 90661 **9.98**

CASE COLLATOR

Fill all four tubes in just 10 seconds. Works with handgun, .380 to 45 Colt.
90667 **14.98**

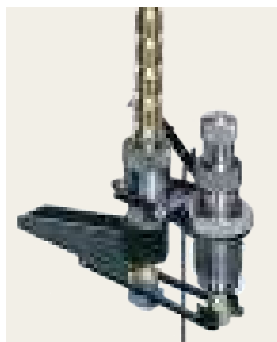

BULLET FEED KIT IS COMPLETE FOR ONE BULLET DIAMETER AND RANGE OF LENGTH. TO CONVERT TO ANOTHER CALIBER OR BULLET LENGTH, SELECT APPROPRIATE FEED DIE AND FINGER & BULLET SEAT AND FEED DIE **48.00**

| FEED KITS COMPLETE | DESCRIPTION | FEED DIE AND FINGERS |
|--------------------|-------------------------------------------|----------------------|
| 90892 | 30 & 32 cal Bullets up to .60 long | 90885 |
| 90893 | 9mm through .365 diameter up to .46 long | 90886 |
| 90894 | 9mm through .365 diameter .46 to .60 long | 90887 |
| 90895 | 9mm through .365 diameter .60 to .75 long | 90888 |
| 90896 | 40 cal through .44 cal up to .65 long | 90889 |
| 90897 | 40 cal through .44 cal .65 to .80 long | 90890 |
| 90898 | 45 cal bullets .50 to .67 long | 90891 |

FOR THE PRO 1000



Shell Plate Carrier **55.98**

To change calibers, the entire Shell Plate Carrier can be replaced. Unit comes complete with Shell Plate, Primer Feed, Case Ejector, Auto-Index and spare parts.

| | |
|-------------------|---------------------------------------------|
| #1 Carrier 90644 | 38 SPL, 357 MAG, etc |
| #2 Carrier 90645 | 45 ACP, etc. |
| #4 Carrier 90646 | 222, 223, 380 AUTO, 32 S&W LONG, 32 H&R MAG |
| #11 Carrier 90650 | 44 SPECIAL, 44 MAGNUM, 45 COLT |
| #19 Carrier 90683 | 40 S&W, 9mm LUGER, 38 SUPER, 38 AUTO, 41 AE |

If you order Shell Plates to convert to another caliber with a different primer size, be sure to order the **PRO 1000 PRIMER ATTACHMENT**

Pro 1000 Primer Attachment 90660 16.00

Small and large priming assemblies included.



Multi-Tube Adapter for Bullet Feed Kit

Four tube magazine keeps Lee Bullet Feeder fed with a continuous supply of bullets. Each tube holds approximately 25 bullets. Quickly and easily installed. Includes large and small adapters, four large and small feed tubes and cylinder, plate assembly.
90280 **27.00**

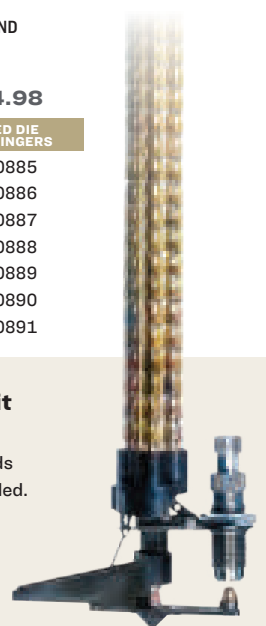

FOR THE LOAD-MASTER



LARGE PRIMER FEEDER

90077 **24.98**

SMALL PRIMER FEEDER

90075 **24.98**



FOLDING PRIMER TRAY 2-PK

90606 **8.00**

ADD A BULLET AND PULL THE LEVER ALL OUR PROGRESSIVE PRESSES WILL PRODUCE A RELOADED ROUND WITH EVERY STROKE. BECAUSE EVERY PULL OF THE LEVER PRODUCES A LOADED ROUND - PRODUCTION

PRO 4000



Shell Plate Carrier 60.98

To change calibers, the entire Shell Plate Carrier can be replaced. Each unit comes complete with Shell Plate, Primer Feed, Case Ejector, Auto-Index and spare parts.

| | | | |
|-----|---------|-------|---------------------------------------------|
| #1 | Carrier | 90644 | 38 SPL, 357 MAG, etc. |
| #2 | Carrier | 90645 | 45 ACP, etc. |
| #4 | Carrier | 90646 | 222, 223, 380 AUTO, 32 S&W LONG, 32 H&R MAG |
| #11 | Carrier | 90650 | 44 SPECIAL, 44 MAGNUM, 45 COLT |
| #19 | Carrier | 90683 | 40 S&W, 9mm LUGER, 38 SUPER, 38 AUTO, 41 AE |

Turret
90497
18.00



Ergonomic wood grip and all-steel linkage

| | |
|----------------------------|--------|
| 32 S&W LONG AND 32 H&R MAG | 90639* |
| 380 AUTO | 90641* |
| 38 SPECIAL AND 357 MAGNUM | 90636 |
| 38 AUTO AND 38 SUPER | 90035 |
| 9MM LUGER | 90640 |
| 40 S&W | 90682 |
| 41 MAGNUM | 90642 |
| 44 SPECIAL AND 44 MAGNUM | 90634 |
| 45 ACP | 90638 |
| 45 COLT | 90643 |
| 223 | 90633* |

INCLUDES SHORT CHARGING DIE.
NOT AVAILABLE IN CARBIDE

*INCLUDES AUTO-DRUM POWDER MEASURE
‡10MM AUTO CAN BE RELOADED. PURCHASE
LARGE TROUGH #TR2164B, PIN #TR2436 AND
10MM LOAD DATA #CD2076

**LEE PRO 1000
COMPLETE, READY TO RELOAD
340.00**

Safe with CCI or Remington brand primers only

◀ Built-in primer disposal tube



SHELL PLATES FOR PRO 4000 shown on page 23

LEE PRO 1000 KIT

Introduced in 1984 as the world's first affordable progressive press. Place a bullet and pull the lever; all other operations are automatic. Load singly or progressively, feeds powder and primers only if case is present.

Recently improved design with better ergonomics, steel frame, positive index pin, roller handle and positive through ram primer disposal.

- Automatically advances cases up to 2 5/16"**
- Quick Change three die turret**
- Set up for specific cartridge and one primer size**
- Safe with CCI or Remington brand primers only**
- Bullet seating and crimping performed in one operation**

Cartridge changeover in seconds, including primer size with no adjustments.

| | |
|---------------------------|-------|
| 45 ACP | 91550 |
| 9mm LUGER | 91555 |
| 38 SPECIAL AND 357 MAGNUM | 91557 |
| 44 SPECIAL AND 44 MAGNUM | 91558 |
| 223 REMINGTON | 91551 |

BIN & BRACKET Catch your loaded rounds. See page 2 90687 14.00

RATES ARE VIRTUALLY IDENTICAL ON OUR PROGRESSIVE PRESSES. ALL OF OUR PRESSES FEATURE AUTOMATIC CASE ADVANCE AND UNIVERSAL CASE FEEDER. ALL ARE SETUP TO LOAD ONE CARTRIDGE. YOU CAN SELECT THE RIGHT PRESS BY THE FEATURES YOU NEED.

KIT SECOND-GENERATION progressive press priced less than many premium single station presses, the lowest priced 4 station progressive available. It is also the easiest to use progressive press ever made. Everything included to begin reloading nothing else to buy.

All the features of the Pro 1000 with an **added fourth station** to allow factory crimping and post sizing. Second generation design features a fixed tool head with quick-change bushings. The Safety Prime is safe with all brands of primers and makes on press priming fast and dependable. The ideal press for loading well used or mixed range brass. So easy to change you're going to enjoy using this press for simple case preparation, like depriming before tumble cleaning. Deactivate the auto index and it is the handiest single station press ever made.

AUTOMATICALLY ADVANCES cases up to 2 5/16." Longer cartridges can be loaded by manually advancing.

AUTOMATIC Universal Case Feed Magazine

MODULAR CONSTRUCTION allows as much or as little automation as the operator desires with no adjustments.

CARTRIDGE CHANGEOVER in seconds, including primer size with no adjustments. Color coded spline drive quick change breech lock bushings.

INCLUDES Large and Small Safety Prime and priming arms. Allows safe dispensing of any brand and size primer.

INCLUDES STORAGE RACK FOR TOOLS, AND HEX WRENCH FOR SHELL PLATE CHANGEOVER. OTHERS CHARGE NEARLY \$30 FOR THIS FEATURE.

INCLUDES ERGONOMIC WOOD GRIP ROLLER HANDLE. OTHERS CHARGE NEARLY \$50.00 FOR THIS FEATURE.

INCLUDES BIN & BRACKET TO CATCH LOADED ROUNDS.

LOAD-MASTER A MASSIVE PRESS WITH ADVANCED FEATURES

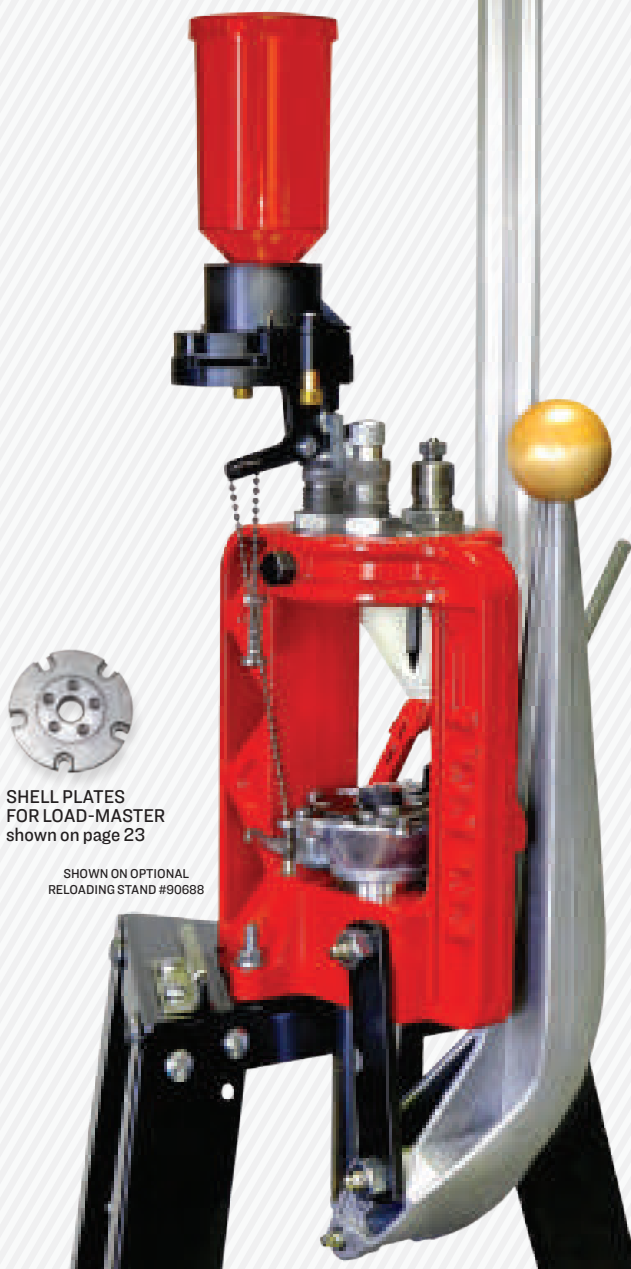

SHELL PLATES FOR LOAD-MASTER shown on page 23

SHOWN ON OPTIONAL RELOADING STAND #90688



Precision 5-Hole Turret with 20 locking lugs takes just seconds to change.
90079 16.00



BIN INCLUDED ORDER ADDITIONAL #90688

Explosion Shield INCLUDED 90363 6.00
Necessary if using primers other than CCI or Remington brand

CALIBERS EQUIPPED WITH RELOADING DIES, PRO AUTO-DISK POWDER MEASURE & CASE FEEDER 420.00

| | |
|--------------------------------|--------|
| 223 REMINGTON | 90922* |
| 32 S&W LONG • 32 H&R MAG | 90935* |
| 9MM LUGER | 90936 |
| 380 AUTO | 90937* |
| 38 SPECIAL AND 357 MAGNUM | 90938 |
| 40 S&W † | 90940 |
| 44 SPECIAL AND 44 MAGNUM | 90943 |
| 45 ACP | 90945 |
| 45 COLT (WILL LOAD 454 CASULL) | 90946 |

* INCLUDES AUTO-DRUM POWDER MEASURE † 10MM AUTO CAN BE RELOADED. PURCHASE LARGE PRIMER FEEDER #90077 AND 10MM LOAD DATA #CD2076

Grease fittings, along with a 1 1/4 inch diameter hard plated ram, ensure a lifetime of service for even the commercial reloader

Stroke and clearance sufficient for largest magnum rifle cases

Loads long rifle cartridges progressively

Load progressively or singly without spilled powder or components.

Five stations so you can factory crimp and post size.

Automatic indexing

Tray feed top of stroke priming system

Removable turret

Loaded round ejector and case catcher

Quick change shell plate. No tools required



Large Primer Feeder 90077 24.98
Small Primer Feeder 90075 24.98

LEE PRO 4000 KIT
INSTALL AUTO BREECH LOCK PIN;
ADJUST YOUR DIES AND BEGIN RELOADING
330.00

AUTO BREECH LOCK PRO PRESS ONLY #90900 170.00

| | | |
|-----------------------------------|-----|-----------------------------------------|
| Auto Breech Lock Pro Press | 170 | PURCHASED SEPARATELY, VALUED OVER \$396 |
| Large & Small Safety Prime | 30 | |
| Auto Drum Powder Measure | 54 | |
| Shell Plate | 25 | |
| Universal Case Feeder | 35 | |
| Reloading Dies | 43 | |
| Bin & Bracket | 14 | |
| Color Coded Spline Drive Bushings | 25 | |

FAST
AND EASY

THE **LEE APP**

AUTOMATIC PROCESSING PRESS

The fastest and easiest way to deprime, size, swage, bulge bust, flare or size cast bullets, period!

Built in case and bullet feeder makes this the fastest single station press ever made.

Frameless design with an all steel linkage allows primer pocket swaging with ease.

Counter balanced handle prevents the handle from falling and pinching a finger.

Almost unlimited visibility and hand clearance.

Compact foot print mounts easily on any bench or table, with no under-swing.

Dirty, gritty, lead contaminated spent primers are 100% captured in a screw top bottle.

Accepts standard 7/8-14 dies and shell holders of any manufacture.

A little over three inches of stroke allows sizing of the larger, belted magnum cartridges.

Priced less than nearly all single station presses makes it a perfect starter press or a perfect companion press to an expensive progressive.

Includes the three most popular X-Press Shell holders 2, 4 and 19



APP Press INCLUDES PRESS, AUTOMATION KIT, BOTTLE ADAPTE AND X-PRESS SHELLHOLDERS 2-4-19
90933 **120.00**

COMES COMPLETE WITH ALL FEED TUBES, TUBE SUPPORTS, RISERS AND CASE SLIDER



Dirty, gritty, lead contaminated spent primers are 100% captured in a screw top bottle

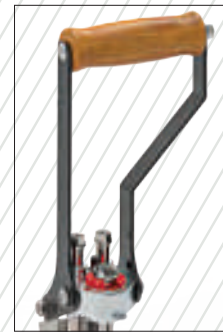

ROLLER HANDLE UPDATE KIT
91629 **30.00**

APP shown on optional Reloading Stand #90688 with Bin & Bracket accessory #90687



X-PRESS SHELL HOLDER
FOR APP
AUTOMATIC PROCESSING PRESS
4.98 ea



X-PRESS SHELLHOLDER SET
CONTAINS 1-2-3-4-5
7-8-9-10-11-19
91622 **40.00**

X-PRESS SHELLHOLDER

The APP gets its speedy operation in part, by the use of a new shell holder. We call it the X-Press Shell Holder. It allows the case to pass through the shell holder after the operations are performed.

| APP SHELL HOLDER | PRODUCT NO. | CARTRIDGES |
|------------------|-------------|---------------------------------------|
| #1 | 91534 | 38 Long & Short Colt, 38 SPL, 357 MAG |
| #2 | 91535 | 45 ACP, 308 Win., 30-06 |
| #3 | 91536 | 30/30, 6.5x55 Mauser, 32/40 |
| #4 | 91537 | 223 Rem, 5.56 NATO, 300 Blackout |
| #5 | 91538 | WSM's, 7mm Rem Mag, 303 British |
| #6 | 91539 | 218 Bee, 25/20, 32/20 |
| #7 | 91540 | 30 M-1, 32 ACP |
| #8 | 91541 | 33 Win, 348 Win, 40/65, 45/70 |
| #9 | 91542 | 41 Magnum |
| #10 | 91543 | 220 Swift, 6.5 Jap, 7x64 Brenneke |
| #11 | 91544 | 44 SPL/MAG, 45 Colt, 303 Savage |
| #12 | 91545 | 22 PPC, 6 PPC, 7.62x39R |
| #13 | 91546 | 45 Auto Rim |
| #14 | 91547 | 44/40, 45 Long Colt |
| #15 | 91548 | 25 ACP |
| #16 | 91549 | 7.62x54 R, 500 S&W |
| #19 | 91552 | 40 S&W, 9mm Luger |
| #20 | 91553 | 17 HORNET, 22 HORNET |
| #21 | 91554 | 6.8 Rem SPC, 224 Valkyrie |

BULGE BUSTER KIT

FOR THE NEW LEE APP



Lee APP Bulge Buster Kit with appropriate Lee Factory Crimp Die restores free function of rimless cases that have low base bulges. Low base bulges usually occur from chambers that do not fully support the cartridge or cases resized in carbide dies from manufacturers other than Lee.

APP BULGE BUSTER KIT 91572 19.98



BRECH LOCK BULLET SIZING KIT

FOR THE NEW LEE APP



Brech Lock Bullet Sizing Kit



THE KIT INCLUDES THE MOUNTING BODY INCORPORATING THE LEE QUICK CHANGE BRECH LOCK FEATURE. The body accepts our new low cost bullet sizing die. The new sizing die is high carbon steel and specially tapered to reduce sizing effort. The sizing die is retained in the mounting body with a dual threaded bottle adapter. Bullets are sized nose first; this is the most accurate and causes the least distortion. Best of all no special top punches are required. Will seat and crimp gas checks while sizing.

Great for powder coated or liquid lubricated bullets. All bullets must be lubricated, order LEE LIQUID ALOX or your favorite coating.

91532 15.00

ORDER BULLET SIZER AND PUNCH BELOW

BULLET SIZER AND PUNCH 12.00



OPTIONAL CASE COLLATOR #90667 pg 23

Other sizes can be made on a custom basis. leeprecision.com/custom-brech-lock-bullet-sizer-punch.html

| PART N° | DIAMETER | PART N° | DIAMETER | PART N° | DIAMETER |
|---------|----------|---------|----------|---------|----------|
| 91505 | .224 | 91514 | .314 | 91523 | .427 |
| 91506 | .225 | 91515 | .323 | 91524 | .429 |
| 91507 | .243 | 91516 | .329 | 91525 | .430 |
| 91508 | .278 | 91517 | .339 | 91526 | .451 |
| 91509 | .284 | 91518 | .356 | 91527 | .452 |
| 91510 | .285 | 91519 | .357 | 91528 | .454 |
| 91511 | .308 | 91520 | .358 | 91529 | .457 |
| 91512 | .309 | 91521 | .401 | 91530 | .501 |
| 91513 | .311 | 91522 | .410 | 91531 | .510 |

PRIMER POCKET SWAGE KIT

DESIGNED EXCLUSIVELY FOR THE LEE APP PRESS

Now you can swage primer pockets as fast as you can operate the press lever



The fastest, most convenient way to swage primer pockets. Will swage large and small primer pockets on any case up to 2½ inches (30/06) long.

No shell holders required!

Large and small swage punches included.

Exclusive, case guided swage push die works without adjustment. It automatically aligns your case mouth to receive the push rod and six guide fingers center the primer pocket to the swage punch. Nothing to adjust—simply install and begin swaging.

Swage adjustment is a finger adjustable knob, no tools required.

APP PRIMER POCKET SWAGE KIT

90237 50.00



DECAPPING DIE

An absolute must for those who clean cases before reloading. No cleaning or lubing needed when using this die. Tough, almost unbreakable decapper easily removes crimped in primers. Fits cases up to .560" in diameter; up to 3.125" long. 90292 14.98

REPLACEMENT DECAPPER UNGUIDED 90783 2.50 | GUIDED 4.00

For smooth operation and less decapper bending or breaking — order caliber specific guided decapper.

- 91574 17 CAL-204 RUGER
- 91576 22 CAL
- 91577 6mm-25 CAL
- 91578 27 CAL-7mm
- 91580 30 CAL
- 91581 34-35 CAL
- 91583 40 CAL
- 91584 45 CAL



UNIVERSAL CASE FEED MAGAZINE

90242 35.00

Automates case feeding process. Most handgun and short rifle, like the 223.

UNIVERSAL CASE EXPANDING DIE



Gently flares the case mouth to accept cast bullets without shaving. Works great to prevent damaging the moly and low friction coatings found on today's high performance jacketed bullets. Includes neck plugs for .22 cal through .45 cal. Works on everything from the 22 Hornet to the largest Ultra Mag. Costs so little and works so well you can't afford to be without one. 90798 16.98



Brech Lock Ram Prime

Start priming in seconds, nothing to adjust. Includes small and large priming assemblies, no tiny parts to fumble with or lose. Effortless priming in the tightest pockets. Uses any brand shell holder. Safe with all brands of primers. Works in any Lee Brech Lock press or adapter. 91612 19.98

91612 19.98

TWO GREAT WAYS TO TRIM CASES QUICK TRIM OR CASE LENGTH GAUGE

FOR SAFETY SAKE, TRIM YOUR CASES

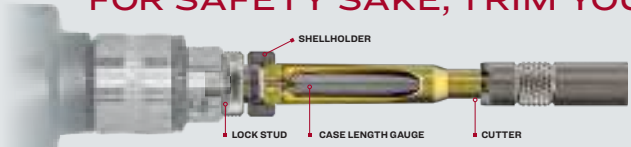

The simplest way to check the case and trim to the correct safe length is with a Lee Case Trimmer.

Lee Case Trimmer

After a case has been loaded a few times, it will stretch beyond maximum length and must be trimmed. There is no better system to check and trim cases than with the Lee Case Length Gauge and cutter. You don't need an expensive caliper to set length and never waste even a single case setting up with the cut and try system common to all other brands. The piloted cutter assures the case mouths are absolutely square and true to the case neck. Best of all, the fixed length design assures it will never go out of adjustment.

The Cutter and Lock Stud works for all calibers. You will need only one. The Case Length Gauge (Pilot) and Shell Holder must be ordered as Case Length Gauge and Shell Holder for each caliber — see chart listing at right and opposite page. You can trim cases by hand, use an electric drill.



CUTTER and LOCK STUD 90110 6.98

Fits cases up to .468" in diameter.

LARGE CUTTER & LOCK STUD 90401 9.98
Can be used on any case.

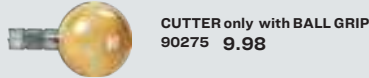

CUTTER only with BALL GRIP 90275 9.98

THREADED LARGE CUTTER AND LOCK STUD 90468 9.98
Large cutter with 8-32 thread shank for use on popular powered case preparation centers.



NEW 3 Jaw Chuck Trimming Kit

91720 27.00

Hex shank fits popular, low-cost cordless screwdrivers.

Universal 3 jaw chuck fits 25 ACP to largest belted magnums without changing shellholders.



Includes cutter and 3 jaw chuck.

Order cartridge specific case length gauge separately.

Trim brass to the correct length while chamfering the case mouth

QUICK TRIM

Lee Quick Trim Case Trimmer

The Deluxe Quick Trim Case Trimmer quickly and precisely trims your brass to the correct length at the same time it chamfers the inside and outside of the case mouth. No calipers, measurement or adjustment required. Simply install the appropriate quick trim die in your press and start trimming. A click adjustable stop allows trim length adjustment in .001 of an inch increments. Allows the user to shorten case to a uniform shorter length than standard, reducing trimming frequency. Includes snap on chip catcher. Order appropriate Quick Trim die for each cartridge listed on chart on upper right and opposite page. **90437 27.00**



| | QUICK TRIM DIE 15.00 | Ltd. Prod. QUICK TRIM DIE 20.00 | CASE LENGTH GAUGE 7.50 | Ltd. Prod. CASE LENGTH GAUGE 12.00 |
|--|----------------------|---------------------------------|------------------------|------------------------------------|
|--|----------------------|---------------------------------|------------------------|------------------------------------|

| | | | | |
|----------------------------|-------|-------|-------|-------|
| 17 Fireball | | | 91347 | |
| 17 Hornet | 90611 | | | |
| 17 Rem | | 90435 | | |
| 204 Ruger | 90439 | | | |
| 218 Bee | | 91350 | | 90225 |
| 219 Zipper | | | | 91305 |
| 22 Hornet | 90354 | | 90111 | |
| *22/250 | 90284 | | 90116 | |
| 220 Swift | | 91370 | 90118 | |
| 221 Fireball | | 91364 | 90112 | |
| 222 Rem Mag | | | | 91283 |
| 222 Remington | 90340 | | 90113 | |
| *223 Remington | 90179 | | 90114 | |
| 223 WSSM | | 91358 | | 90673 |
| 224 Valkyrie | 90868 | | 91339 | |
| 225 Winchester | | | | 91280 |
| 240 Weatherby Magnum | | | | 91281 |
| 243 Winchester | 90320 | | 90119 | |
| 243 WSSM | | 91341 | | 90389 |
| 25 WSSM | | | | 90221 |
| 25-20 Winchester | | 91385 | | 90121 |
| 25-35 Winchester | | | | 91306 |
| 25-06 Remington | 90334 | | 90124 | |
| 25-20 Winchester | | | | 90121 |
| 250 Savage (250/3000) | | 91374 | | 90122 |
| *257 Roberts | | 91357 | 90123 | |
| 257 Weatherby Magnum | | 91342 | 91298 | |
| 26 Nosler | | 90637 | | 91307 |
| 260 Remington | 90399 | | 90993 | |
| 264 Winchester Magnum | | | | 91308 |
| 270 Weatherby Magnum | | | | 91279 |
| 270 Winchester | 90229 | | 90128 | |
| 270 Winchester Short Mag | 90393 | | 90117 | |
| 28 Nosler | | | | 91284 |
| 280 REM ACK IMPROVED | | 91375 | | 91295 |
| 284 Winchester | | 91362 | | 90129 |
| 30-378 Weatherby Magnum | | | | 91309 |
| 30-40 Krag | | 91354 | 90137 | |
| 30/06 Springfield | 90291 | | 90140 | |
| *30/30 Winchester | 90249 | | 90136 | |
| 300 AAC Blackout | 90689 | | 90443 | |
| 300 H&H | | 90407 | | |
| 300 H&H or Ultra Magnum | | | 90141 | |
| 300 HAM'R | | 91609 | | |
| 300 RSAUM | | 91343 | | |
| 300 Remington Ultra Magnum | | 91366 | | |
| 300 Savage | | 91356 | 90138 | |
| 300 Weatherby Magnum | | 90408 | 90143 | |
| 300 Winchester Magnum | 90441 | | 90142 | |
| 300 Winchester Short Mag | 90484 | | 90034 | |
| 303 British | 90325 | | 90144 | |
| 303 Savage | | 91383 | | |
| 308 Marlin | | 91352 | | |

Chamfer Tool Must be used after Case Trimming. Unique design cuts fast without chatter. One turn does the job. Chamfers and deburrs inside and outside of case necks. Can also be used to remove the crimp from primer pockets of military brass. Works better than tools costing several times as much. **90109 3.98**



Primer Pocket Cleaner Double ended design cleans both large and small primer pockets. Primers can be fully seated for better accuracy and safety. Costs so little and works so well, no reloader can afford to be without one. **90101 2.98**



Case Conditioning Kit Includes cutter and lock stud, chamfer tool and primer pocket cleaner. **90950 12.98**



Decapper & Base Easily removes crimped in primers from military cases. Guaranteed unbreakable.

22 Caliber 90103 30 Caliber 90102 7.98



The ultimate in case trimming, speed and convenience Deluxe Power Quick Trim

Trim and chamfer in a matter of seconds. Hex shank snaps in to cordless screwdriver or drill (sold separately) Includes power Quick-Trim adapter, chip catcher and deluxe cutter assembly. To complete your trimming setup, order cartridge specific pistol or rifle Quick Trim die from list above.



Cordless screwdriver pictured is not included.

| | QUICK TRIM DIE 15.00 | Ltd. Prod. QUICK TRIM DIE 20.00 | CASE LENGTH GAUGE 7.50 | Ltd. Prod. CASE LENGTH GAUGE 12.00 |
|---------------------------------------------|----------------------|---------------------------------|------------------------|------------------------------------|
| 308 Norma Magnum | | | | 91289 |
| 308 Winchester | 90231 | | 90139 | |
| 32 Winchester Special | | | | 90491 |
| 32-40 Winchester | | 91376 | | 91312 |
| 325 WSM | | 91344 | | 90222 |
| 327 Federal Magnum | | | | 91303 |
| 338 Edge | | | | 91313 |
| 338 Federal | | | | 90218 |
| 338 Lapua | | | 90462 | |
| 338 Remington Ultra Magnum | | | | 91314 |
| 338 Winchester Magnum | 90391 | | 90149 | |
| 340 Weatherby Magnum | | 91346 | | 91223 |
| 348 Winchester | | 91360 | | 91304 |
| 35 Remington | 90403 | | 90150 | |
| 35 Whelen | | 91355 | 90972 | |
| 350 Legend | | 91561 | 91567 | |
| 350 Remington Magnum | | 91377 | | 91315 |
| 358 Winchester | | | | 91318 |
| 358 WSSM | | 91378 | | |
| 375 H&H | 90395 | | | |
| 375 H&H or Ultra Mag | | | 90164 | |
| 375 Ruger | | 90613 | | 91285 |
| 375 Socom | | | | 91319 |
| 375 Super Magnum | | | | 91320 |
| 375 Winchester | | 91371 | | 90165 |
| 40-65 Winchester | | 91384 | | 91323 |
| 416 Rigby | | | | 91324 |
| 416 Ruger | | | | 91294 |
| 43 Spanish | | 91367 | | |
| 444 Marlin | | 91372 | 90151 | |
| 45/70 Government | 90458 | | 90152 | |
| 45/70 LEVERevolution | | | | 91287 |
| 450 Bushmaster | | | 91325 | |
| 450 Marlin | | | | 90554 |
| 458 Lott | | | | 91326 |
| 458 Socom | | | 91290 | |
| 458 Winchester Magnum | | 91345 | | 90971 |
| 50 Beowulf | | | 91292 | |
| 50 BMG <small>REQUIRES LARGE CUTTER</small> | | | 90010 \$22.00 | |
| 6.5 Carcano | | 91353 | | 90043 |
| 6.5 Creedmoor | 90812 | | 90814 | |
| 6.5 Grendel | 90763 | | 91278 | |
| 6.5 PRC | | 91348 | 91533 | |
| 6.5 x 284 | | | 90223 | |
| 6.5 x 55 Swedish Mauser | 90337 | | 90126 | |
| 6.5-06 | | | | 91108 |
| 6.5X284 | | 91361 | | |
| 6.5X47 Lapua | | 91381 | | 91330 |
| 6.5X50 Japanese | | | | 91331 |
| 6.5X57 Mauser | | | | 91291 |
| 6.8 SPC | 90397 | | 90189 | |
| 6MM BR NOR/RE | | | | 91296 |
| 6mm Creedmoor | 90658 | | 91340 | |
| 6MM PPC | | 91349 | | 91282 |
| 6mm Remington (244 Rem.) | | 90434 | 90120 | |
| 6MM TCU | | | | 91286 |
| 6MM XC | | | | 91328 |
| 6X45MM | | | | 91329 |
| 6X47 Lapua | | 91380 | | 91302 |
| 7 x 57 Mauser | 90489 | | 90130 | |

| | QUICK TRIM DIE 15.00 | Ltd. Prod. QUICK TRIM DIE 20.00 | CASE LENGTH GAUGE 7.50 | Ltd. Prod. CASE LENGTH GAUGE 12.00 |
|------------------------------------------------|----------------------|---------------------------------|------------------------|------------------------------------|
| 7 x 64 Brenneke | | | | 90236 |
| 7-30 Waters | | | | 91335 |
| 7.35 Carcano | | | | 91293 |
| 7.5 x 55 Swiss (Schmidt-Rubin) | 90419 | | 90132 | |
| 7.5 x 54 MAS | | 91359 | | 90051 |
| 7.62 x 39 Russian | 90345 | | 90133 | |
| 7.62 x 54 Russian | 90342 | | 90147 | |
| 7.62 x 40 Wilson Tactical | | | | 91300 |
| 7.65 x 53 Mauser (Belgian-Arg) | | 91382 | | 90134 |
| 7.7 x 58 Japanese Arisaka | | 91368 | 90115 | |
| *7mm Express/280 Rem. | 90412 | | 90166 | |
| 7mm Remington Magnum | 90297 | | 90131 | |
| 7MM RUM | | | | 91333 |
| 7MM STW | | | | 91332 |
| 7MM Weatherby Magnum | | | | 91334 |
| 7mm Winchester Short Mag | | | 90314 | |
| 7mm/08 | 90343 | | 90167 | |
| 7X64 Brenneke | | 91386 | | |
| 8x56 Aust-Hung Mannlicher | | | | 90589 |
| 8x57 Mauser | 90347 | | 90148 | |
| 8MM Remington Magnum | | | | 91337 |
| 8X68MM S | | | | 91288 |
| 9.3x62 Mauser | 90614 | | 91299 | |
| 9.3x74 R | | | | 91301 |
| 22 TCM | | 91373 | | |
| 5.7 x 28 FN | | 91363 | 90219 | |
| 30 M1 Carbine | 90365 | | 90135 | |
| 9mm Makarov | 90181 | | | 90684 |
| 9mm Luger | 90032 | | 90153 | |
| 357 SIG | | | | 91317 |
| 38 Super | | | | 90217 |
| 380 Auto | 90025 | | 90155 | |
| 30 Herrett | | | | 91297 |
| 7.62X25 Tokarev | | | 91336 | |
| 32 ACP | | | | 91338 |
| 32 S&W | | | | 91311 |
| 32 Smith & Wesson Long | | | | 90169 |
| 32 H&R Magnum | | | | 91310 |
| 32-20 Winchester | | 91365 | 90146 | |
| 38 S&W | | | | 90156 |
| 38 Special | 90085 | | 90157 | |
| 38-40 Winchester | | 91351 | | 91322 |
| 38-55 Winchester | | 91379 | 90994 | |
| 357 Magnum | 90088 | | 90158 | |
| 357 MAX | | | | 91316 |
| 40 S&W | 90033 | | 90154 | |
| 10mm Auto | 90193 | | 90127 | |
| 38 Short Colt | | | | 91321 |
| 41 Magnum | | 90226 | 90159 | |
| 44-40 Winchester | | 91369 | 90168 | |
| 44 Special | 90107 | | 90160 | |
| 44 Magnum | 90125 | | 90161 | |
| 45 ACP | 90073 | | 90162 | |
| 45 Colt | 90145 | | 90163 | |
| 45 GAP | | | | 91473 |
| 454 Casull | | 90174 | 90992 | |
| 460 S&W | | | | 90220 |
| 480 Ruger <small>REQUIRES LARGE CUTTER</small> | | | | 90018 |
| 50 Action Express | | | | 91327 |
| 500 S&W <small>REQUIRES LARGE CUTTER</small> | 90178 | | 90019 | |

UNLISTED RIFLE QUICK TRIM DIES can be custom made. leeprecision.com/custom-rifle-quick-trim-die-body.html

UNLISTED CASE LENGTH GAUGES can be custom made. leeprecision.com/custom-case-length-gauge.html

NEW Ram Swage

Primer pocket swager works so fast that you'll want to swage all the range brass you pick-up. Works on all single stage presses with 7/8"-14 threads and accepts universal press shell holders. Features spring assisted case extraction, and an all steel case guide, ensures cases will be positively centered on push rod. Shell holderless design, allows you to swage any small or large primer pocket, without swapping to a different size shell-holder.

91617 50.00

LEE BULGE BUSTER KIT

Assure your mixed brass is bulge free with the Bulge Buster Kit and appropriate Lee Carbide Factory Crimp Die. This push through die adapter will quickly remove the annoying bulge rings that shell holder constrained dies simply can't reach. The Bulge Buster Kit includes extension sleeve, push through punch, catch container and complete instructions. And it's fast — you can reprocess your cases as quickly as you can handle them.

CARBIDE FACTORY CRIMP DIES, SEE PAGE 7

Bulge Buster Kit 90487 19.98

Utilize all your brass by removing annoying bulge rings

BULGE BUSTER KIT shown mounted to Breech Lock Reloader Press (90045). Sold separately, pg. 18

WITH THE LEE FACTORY CRIMP DIE, THE BULGE BUSTER WILL REPAIR ALL THESE RIMLESS CASES

- 90867 380 ACP
- 90862 10 mm
- 90862 40 S&W
- 90416 41 AE
- 90864 45 ACP
- 90864 45 GAP
- 90864 45 Win Mag

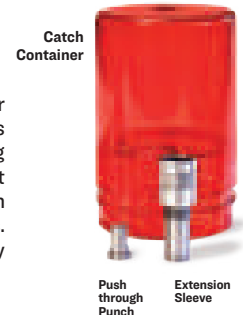

Pictured with
CASE COLLATOR #90667
Sold separately pg. 23



ACP AUTOMATIC CASE PRIMER

**INTRODUCING
THE NEXT REVOLUTION IN PRIMING.
THE WORLD'S FIRST AUTOMATICALLY CASE FED,
SHELL HOLDER-LESS PRIMING TOOL
THE ACP**

METALLIC CARTRIDGE PRIMING was revolutionized in 1979 with Richard Lee's patented **AUTO PRIME** tool. Today, the majority all hand-held priming tools share most, if not all, features of the Original Auto-Prime. The new ACP truly automates priming. Think of it as the "REAL" AUTO-PRIME. This is the nicest priming tool ever made. No shell holders required; cases are guided into position by our new "finger guide" — priming is positive, effortless and uniform. Positive and consistent seating depth is assured with our new dead length priming device. Primers are seated uniformly without "feel" or adjustments required. Seating is almost effortless as the priming tool shares the powerful linkage of our Automatic Processing Press. And the best feature is the ability to automatically feed cases! Nothing else to buy — will seat large and small rifle and pistol primers. Automatically feeds and primes cases up to 2½ inches long.

ACP - AUTOMATIC CASE PRIMER

91610 **120.00**



Depriming Kit

Use your ACP as the world's fastest, shellholderless depriming tool. Great for those who tumble clean cases before reloading. Includes screw top catch bottle for spent primers and debris.

91714 **10.00**

Pictured with
UNIVERSAL CASE FEED MAGAZINE
Sold separately #90242

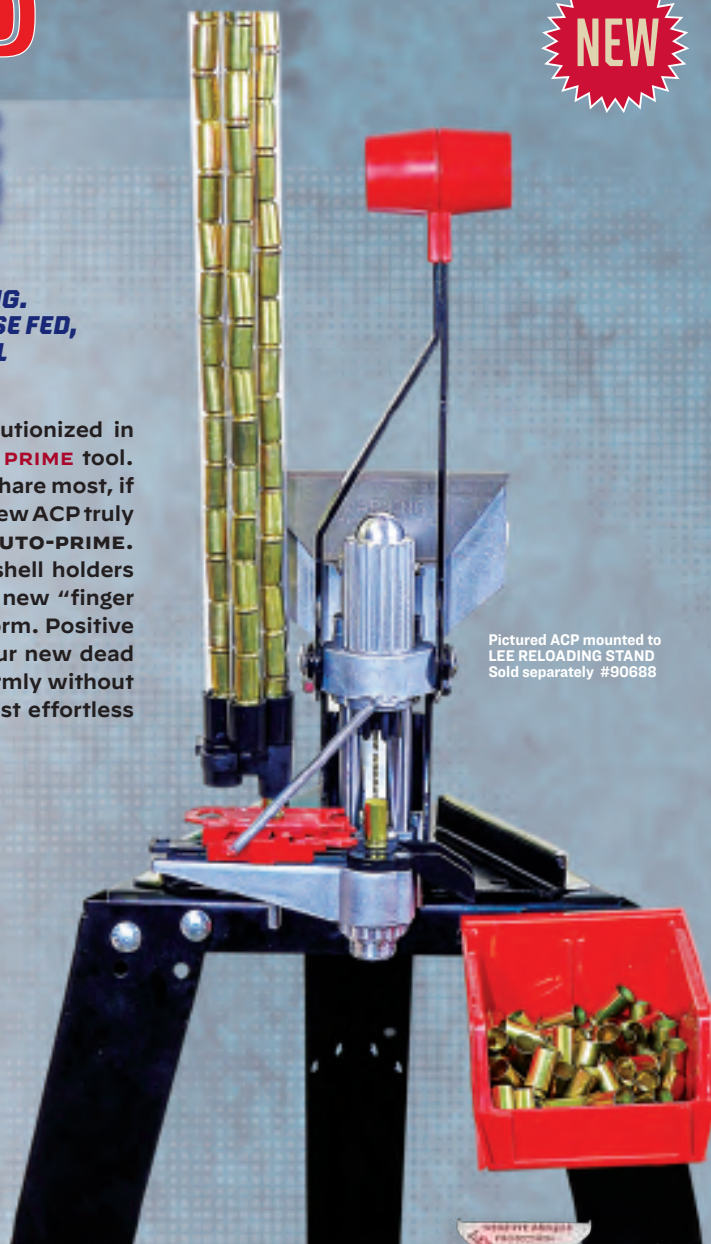

Pictured ACP mounted to
LEE RELOADING STAND
Sold separately #90688

THE EASIEST, MOST CONVENIENT BENCH MOUNTED PRIMING tool ever. Symmetrical design allows effortless right or left hand operation. Comfortable lever with just the right amount of mechanical advantage effortlessly seats even the most difficult primers with just finger pressure. Perfect mechanical advantage to feel the primer seating completely home into the primer pocket.

Includes priming assemblies for large and small primers. Change primer size or shell holder in seconds.

Includes the patented folding tray — go from box to priming in seconds. No need for a heavy bench; fits the Lee Bench Plate or mount to a board for a portable setup.

AUTO BENCH PRIME



Folding Primer Tray

TWO PACK 90606 **8.00**

Tray's built-in flipping surface quickly rights and orients primers—go from box to priming in seconds. Patented elevator pin safely isolates a single primer for priming. Allows most primer brands and types to be safely tray fed. The convenient hinged cover allows you to individually feed primers if restricted by the primer manufacturer.

Auto Bench Prime

90700 **41.98**

OFF PRESS PRIMING

Lee Ergo-Prime

Premium hand held priming tool with all the features of the world's most popular Auto-Prime, with ERGOnomic design. The Ergo Prime's highly sculpted body fits your hand perfectly, along with a long smoothly contoured finger lever that easily installs the tightest primers. Fingertip operation provides unmatched sensitivity and comfort, especially for older hands. Change primer size in an instant—no tools or disassembly required, simply remove shell holder and swap primer assembly. Powder coated metal body and polished chrome plated lever makes the Ergo-Prime not only the most comfortable, but also the best looking tool made. Comes packed in a convenient storage box to keep your tool and shellholders together. 90250 49.00



New Auto-Prime

The original and world's most popular hand-held priming tool. Fast and economical hand held priming with unmatched feel and accuracy. Comes packed in a convenient storage box to keep your tool and shellholders together. 90230 31.98



COMFORT GRIP

Save even more! Purchase a kit!



Priming Tool Kit

Includes the New Auto-Prime, and nice molded storage box. Holds everything, including a complete set of shell holders. This kit comes with 8 of the most popular priming tool shell holders, works with over 130 different cartridges. 1, 2, 3, 4, 5, 11, 12, 19. Holds an additional 8 shell holders. This kit is a convenient way to keep your tool and shell holders all in one spot. 90215 41.98

Priming Tool Storage Box

Holds your Ergo-Prime or New Auto Prime tool. With room for 18 priming tool shell holders. 90426 5.98

New, removeable tray PATENTED



Unfold tray and place on top of box of 100 primers.

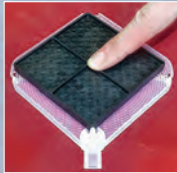

Flip tray over to deposit the primers.



Shake tray to upright all the primers. Fold and close cover.



Slide the flow control to LOCK.



Set of Shellholders

Eleven of the most popular sizes fit over 115 different cartridges. The chart (below) is included with each shell holder set.

Packed in a lifetime plastic box

1 · 2 · 3 · 4 · 5 · 7 · 8 · 9 · 10 · 11 · 19

RED STORAGE BOX ONLY 90196 4.98

SHELL HOLDER SET 90198 23.98

with 11 Shellholders for LEE PRIMING TOOLS AND THESE OTHER FINE TOOLS—K&M, SINCLAIR, F A PLATINUM, CPS, 21ST CENTURY

ALL OFF-PRESS PRIMING TOOLS USE SPECIAL, BUT INEXPENSIVE PRIMING TOOL SHELL HOLDERS, SO THERE'S NO NEED TO ENDLESSLY SWAP PRESS SHELL HOLDERS TO PRIME.

| SHELL HOLDER | FOR PRIMING TOOL SHELL HOLDERS 2.98 |
|--------------|-------------------------------------|
| #1 | 90201 |
| #2 | 90202 |
| #3 | 90203 |
| #4 | 90204 |
| #5 | 90205 |
| #6 | 90206 |
| #7 | 90207 |
| #8 | 90208 |
| #9 | 90209 |
| #10 | 90210 |
| #11 | 90211 |
| #12 | 90212 |
| #13 | 90213 |
| #14 | 90272 |
| #15 | 90017 |
| #16 | 90200 |
| #17 | N/A |
| #18 | N/A |
| #19 | 90023 |
| #20 | 90020 |
| #21 | 90031 |
| #24 | 91495 |
| #25 | 91496 |

| HOLDER | RIFLE | HOLDER | RIFLE | HOLDER | RIFLE | HOLDER | RIFLE | HOLDER | PISTOL |
|--------|--------------------|--------|----------------------|--------|----------------------|--------|------------------|--------|----------------------|
| 20 | 17 Hornet | 2 | 250 Savage | 12 | 7.62mm x 39 | 2 | 35 Remington | 7 | 32 ACP |
| 4 | 17 Remington | 3 | 25/35 | 16 | 7.62x54 Russian | 5 | 35 Winchester | 4 | 32 Colt N.P. |
| 4 | 204 Ruger | 4 | 25/45 Sharps | 3 | 30 Herrett | 2 | 35 Whelen | 4 | 380 Auto |
| 4 | 22 TCM | 2 | 257 Roberts | 3 | 30/30 Win. (30 WCF) | 5 | 350 Rem. Mag. | 19 | 9mm LUGER |
| 20 | 22 Hornet | 5 | 257 Weatherby | 2 | 300 Savage | 3 | 356 Winchester | 1 | 38 S & W |
| 20 | 22 K Hornet | 2 | 6mm Creedmoor | 16 | 30/378 | 2 | 358 Winchester | 1 | 38 Colt N.P. |
| 3 | 22 Savage | 2 | 6.5mm Creedmoor | 21 | 30 Remington | 5 | 358 Norma Magnum | 19 | 38 Super Auto |
| 2 | 22 BR | 2 | 6.5mm 06 | 2 | 308 Win. (7.62 NATO) | 3 | 375 Winchester | 19 | 38 ACP |
| 6 | 218 Bae | 2 | 6.5mm x 57 | 4 | 300 AAC Blackout | 5 | 375 H & H | 1 | 38 Short Colt |
| 12 | 22 PPC | 3 | 6.5 x 55 Mauser | 5 | 30/40 Krag (30 U.S.) | 5 | 375 Weatherby | 1 | 38 Long Colt |
| 3 | 219 Zipper | 10 | 6.5 Jap | 2 | 30/06 Springfield | 5 | 375 Ultra Magnum | 1 | 38 Special - 357 Mag |
| 10 | 220 Swift | 5 | 6.5 Rem. Magnum | 5 | 300 H & H | 5 | 375 Ruger | 19 | 357 Sig |
| 4 | 221 Fireball | 2 | 6.5 Carcano | 5 | 300 Weatherby | 14 | 38/40 Win. | 2 | 357 Auto Magnum |
| 4 | 222 Remington | 12 | 6.5 Grendel | 5 | 300 Win Magnum | 3 | 38/55 Winchester | 19 | 40 S&W - 10mm Auto |
| 4 | 222 Rem. Magnum | 5 | 264 Win. Magnum | 5 | 300 Ultra Magnum | 8 | 40/82 Winchester | 1 | 41 Long Colt |
| 4 | 223 (5.56mm) | 5 | 26 Nosler | 5 | 300 Win S Magnum | 5 | 416 Remington | 19 | 41 Action Express |
| 5 | 223 WSSM | 21 | 6.8 SPC | 5 | 308 Norma Magnum | 25 | 416 Rigby | 9 | 41 Magnum |
| 2 | 224 Clark (22/257) | 2 | 270 Winchester | 5 | 303 British | 18 | 43 Mauser | 11 | 44 S&W Spl - 44 Mag |
| 21 | 224 Valkyrie | 5 | 270 Weatherby | 2 | 7.7 Japanese | 17 | 43 Spanish | 11 | 44 S & W Russian |
| 10 | 225 Winchester | 5 | 270 Win S Mag | 3 | 32 Win. Spcl | 14 | 44/40 | 2 | 44 Auto Mag. |
| 2 | 225/250 | 2 | 280 Remington | 3 | 32 Win. S.L. | 11 | 444 Marlin | 2 | 450 Auto |
| 2 | 240 Weatherby | 2 | 7mm/08 | 6 | 32/20 (32 W.C.F.) | 8 | 45/70 Gov't | 11*14 | 45 Colt |
| 2 | 243 Win. | 2 | 7mm BR | 3 | 32/40 Winchester | 2 | 450 Bushmaster | 14 | 45 Schofield |
| 5 | 243 WSSM | 4 | 7mm TCU | 2 | 8 x 57 Mauser | 5 | 458 Win. Magnum | 11 | 454 Casull |
| 2 | 6mm Remington | 3 | 7 x 30 Waters | 2 | 8mm 06 | | | 14 | 460 S&W |
| 2 | 244 Remington | 2 & 10 | 7 x 57mm Mauser | 2 | 8mm Man. Schoe. | 15 | 5.7 x 28 | 5 | 455 Webley |
| 2 | 6mm Int'l | 5 | 7 x 61 Sharpe & Hart | 5 | 8mm Rem. Magnum | 1 | 22 Rem. Jet | 13 | 45 Auto Rim |
| 2 | 6mm/284 | 5 | 7mm Rem. Magnum | 17 | 8mm Lebel | 15 | 25 ACP | 3 | 45 Win. Magnum |
| 2 | 6mm/06 | 5 | 7mm Win S Mag | 16 | 8x56R Hungarian | 1 | 256 Win. Magnum | 5 | 480 Ruger |
| 12 | 6 PPC | 5 | 7mm Weatherby | 8 | 33 Winchester | 19 | 30 Luger | 5 | 475 Linebaugh |
| 4 | 6 x 47 (6mm/222M) | 5 | 7mm Ultra Mag | 25 | 338 Lapua | 19 | 30 Mauser | 16 | 500 S&W |
| 2 | 25/284 | 2 | 284 Winchester | 5 | 338 Win. Magnum | 4 | 32 Short Colt | | |
| 5 | 25/303 | 3 | 7.5mm Schmidt-Rubin | 5 | 338 Ultra Magnum | 4 | 32 Long Colt | | |
| 2 | 25/06 | 7 | 30 M 1 Carbine | 5 | 340 Weatherby | 4 | 32 S & W | | |
| 6 | 25/20 Winchester | 3 | 7.65x53 Arg. Mauser | 8 | 348 Win. | 4 | 32 S & W Long | | |

INCLUDES THE NEW POWDER MEASURE BOTTLE ADAPTER

DELUXE PERFECT POWDER MEASURE

QUALITY CONSTRUCTION

This powder measure features a high pressure die cast, diamond-machined body. The precision-machined rotor drum is cast from brass, which is naturally anti-static and spark proof.

ELIMINATES CUT POWDER AND JERKY ACTION

A soft elastomer wiper strikes off the metering chamber rather than cut the powder. You'll be surprised at how smoothly the rotor operates. More importantly, you will enjoy the most uniform of charges.

EASY TO SET & READ MICROMETER METERING CHAMBER

Powder charge adjustment is accomplished with a true micrometer adjustable metering chamber. The metering chamber is aluminum with a black anodized finish. Features a crisp, permanent, laser engraved scale. The brass micrometer thimble is engraved with .01cc graduations and has a releasable detent lock. With most rifle powders each click is about a 1/10 of a grain, perfect for working up a load.

CHANGING POWDER IS FAST AND EASY

Features easily removable hopper with an on/off valve so you can quickly return unused powder to its original container or switch to another type. The hopper feeds to a pre-measuring chamber allowing precise charges regardless of the powder level in the hopper, eliminates the need for an extra powder baffle.

QUICK CHANGE DRUMS

One of the nicest features is the ability to use the new Lee standard quick-change drums (product # 90453). These low cost drums can be preset to your favorite charge and swapped out in seconds.

DELUXE PERFECT POWDER MEASURE 90699 80.00

NO POWDER MEASURE, REGARDLESS OF PRICE, HAS ALL THE FEATURES OF THE LEE DELUXE POWDER MEASURE

PERFECT FOR USE WITH THE DELUXE PERFECT POWDER MEASURE & AUTO-DRUM



QUICK CHANGE DRUM SET features four precision molded nylon drums. Two small capacity for cases as small as the 25 ACP, adjustable to 223 size rifle cases. Large capacity drums adjustable from 223 case to cases as large as the belted magnums. The large drums include an insert to allow reduced capacity charging like the small drum. All drums are infinitely adjustable within range. No tools required for adjustment. A graduated adjustment key is included with each drum. Each key is marked with .01cc graduations, allowing easy 1/10-grain powder adjustments.

Quick Change Drum Set 90453 20.00

POWDER MEASURE BOTTLE ADAPTER

POWDER MEASURE BOTTLE ADAPTER FITS ALL LEE POWDER MEASURES



Allows dispensing powder directly from the shipping container of most popular powder manufactures. Includes a crystal clear bottle that holds over a half a pound of ball powder. Works on all of these and many more.

(53mm or 43mm thread)

Dispensing powder directly from the bottle assures positive identification of the powder type.

Adapter is manufactured from

Polypropylene—resistant to attack from all

types of powder. Now you can turn off the powder flow and store your powder in its original container with no fear of misidentifying or damage to your hopper from chemical attack. Viewing window allows monitoring powder level in use without removing bottle.

Bottle Adapter 91586 8.00



Powder Measure Stand

Heavy, powder coated steel construction

7/8" mounting hole for all popular measures

Includes 3 no slip feet

Rock solid mount improves measure consistency

Space saving freestanding design is portable and convenient.

Works with other brands of powder measures

Powder Measure Stand 90587 35.00



Lee Safety Scale

Safety and accuracy are the most important features

This is the only scale that can never get out of adjustment. The beam is made from a very tough phenolic, the same type material used on table and counter tops. Phenolic is tough but, like glass, it can't be bent. Even if dropped you can feel confident that if it did not break it is still accurate. Sensitive and readable to 1/20 grain.

90681 43.98

READ THIS if you already have a combination bullet and powder scale

Try this simple test to see how sensitive your scale really is. Cut a piece of regular writing paper or this catalog 5/16 inch square. With scale set on zero — drop the paper on the pan to see if it moves. It should read about .1 grain. Keep adding paper squares until it does move. The total number of squares needed to move your scale is your scale's sensitivity. We have seen digital powder scales that are only sensitive to 1/2 grain (FIVE paper squares!) A Lee Safety Scale will move with the first paper.

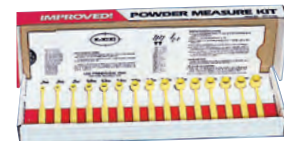

Lee Powder Measure Kit

Fifteen uniformly graduated and proportioned powder dippers. Slide card shows the grains of powder each measure will dispense of every type of powder. Powder measures are inherently safe as they cannot get out of adjustment. That's why powder dippers continue to be the first choice of reloaders who load in small quantities.

90100 13.98

Powder Funnel

A large, unbreakable funnel that fits all cases from .22 to .45 caliber. Hole in flange permits mounting to the Lee Turret Press, shelf or bench.

90190 3.98



INCLUDES THE NEW POWDER MEASURE BOTTLE ADAPTER

The Original Perfect Powder Measure

Almost as good as a scale!

Solves problems common to ordinary drum type measures. Gives you the confidence that your charges will be the most uniform possible.

Lee Perfect Powder Measure

Includes many of the features of the Deluxe Perfect Powder Measure, but the body is molded from an engineering grade polymer. Rotating micrometer adjustable metering chamber and elastomer wiper to prevent powder cutting. Works better than other powder measures priced four times as much.

90058 30.98



FREE STURDY STEEL MOUNTING BRACKET INCLUDED WITH EACH MEASURE

PICTURED ON OPTIONAL STAND # 90587, SOLD SEPARATELY

CHARGE CASES WHILE EXPANDING THE CASE MOUTH

AUTO DRUM

Automatic case actuated drum powder measure. Accurately and automatically dispense powder in your favorite cartridge. Two infinitely adjustable drums included. Quick Change drums will accurately and reliably drop charges from 1 to 80 grains of powder.



"MODERN RELOADING" AND ALL POPULAR LEE DIE SETS INCLUDE LOAD DATA

Lee Pro Auto-Disk Powder Measure

Commercial reloaders or competitive shooters first choice! Elastomer wiper and polytetrafluoroethylene (PTFE) non-stick metal casting make this the smoothest operating measure. Large hopper with integral shut-off valve makes changing powder or disks super convenient. Brass thumbnuts attach the hopper to the body so you can change disks with no tools. Rubber wiper and seal prevents powder shearing and makes it more leak-resistant with fine-grain powders. Increased safety with positive pull-back lever.

The measure is attached to the die with a swivel adapter, allowing easy positioning and quick removal when changing cartridges. Included positive pull back lever reduces the chance of double charge when progressive reloading.

Lee Pro Auto-Disk Powder Measure
INCLUDES ALL FOUR DISKS
90429 58.00



INCLUDES THE NEW POWDER MEASURE BOTTLE ADAPTER

Case actuated; never spill a charge.

Exclusive elastomer wiper prevents powder shearing, works great with difficult metering extruded powders.

Machined body with labyrinth groove mates to precision molded nylon drums providing leak free fit with the finest powders.

Drum is actuated by a steel sector and pinion gear train.

Quick-change hopper has on/off valve Sleek modern design, all gears springs and levers inside the die cast housing.

Same swivel adapter as our famous Pro Auto-Disk powder measure. Makes moving measure fast and convenient.

HANDGUN AND RIFLE DRUMS INCLUDED.

AUTO-DRUM POWDER MEASURE
90811 54.00



| PRO AUTO-DISK POWDER MEASURE | |
|----------------------------------------|------------------------------------------------------------------------------------|
| CARTRIDGE RANGE | 9 MM TO 45 COLT |
| USE | IDEAL FOR HANDGUN |
| SIMPLE SET UP | NOTHING TO ADJUST, NOTHING TO GET OUT OF ADJUSTMENT USE LEE PUBLISHED LOAD DATA |
| CONSISTENCY | EXTREMELY CONSISTENT INCREMENTAL CHARGES |
| WIPER TO PREVENT POWDER SHEARING | YES |
| SWIVEL ADAPTER FOR FAST, EASY TRANSFER | YES |
| ON/OFF VALVE | YES |

| AUTO-DRUM POWDER MEASURE | |
|----------------------------------------|------------------------------------------------------------------------|
| CARTRIDGE RANGE | 25 AUTO TO 300 WIN MAG |
| USE | IDEAL FOR BOTH HANDGUN AND RIFLE |
| ADJUSTABILITY | INFINITELY ADJUSTABLE WITH INCLUDED SMALL AND LARGE QUICK CHANGE DRUMS |
| CONSISTENCY | EXTREMELY CONSISTENT .01 CC INCREMENTAL CHARGE ADJUSTMENT |
| WIPER TO PREVENT POWDER SHEARING | YES |
| SWIVEL ADAPTER FOR FAST, EASY TRANSFER | YES |
| ON/OFF VALVE | YES |

The Pro Auto-Disk comes with a complete set of four disks. Each disk has six cavities, so you get 24 cavities in all. The chart included on the rear of the instruction sheet lists the capacity of each cavity with every type of powder. If you reduce your charge 10% you can safely use this data without weighing your charge. Fixed cavities are the safest way to meter powder because they can't be misadjusted or get out of adjustment.

PRO AUTO-DISK ACCESORIES



Adjustable Charge Bar

Infinitely adjustable between .28 and 1.6 cc. Lifetime nylon with solid brass, zero backlash micrometer. Easy to set.

Adjustable Charge Bar
90792 9.98

Double Disk Kit (not pictured)

This kit raises the hopper so you can stack two disks. Not only doubles the capacity of the disks but it makes very fine adjustments possible. Most powders can be adjusted up or down .1 grain with different combinations of disks. Complete listing of combinations, 4 extra disks, screws and risers are included.

Lee Double Disk Kit
90195 14.98

Lee Rifle Charging Die Kit

Short and Long Charging Dies are included. These dies work the same as the pistol powder through expanding dies, except they do not expand the case mouth. Rifle case expansion is done in the sizing die. Can be used on 22 caliber, and up to the largest belted magnums.

Charging Die kit
90995 26.00

SHORT CHARGING DIE
22 HORNET TO 223 REM
90668 14.98

LONG CHARGING DIE
223 REM TO 300 WIN MAG
90194 14.98

Powder Measure Riser

Installs between the Lee Powder through Expanding Die or Rifle Charging Die and Powder Measure. Allows convenient use of other brands of dies that have extended adjusting screws and provides clearance for the Lee Safety Prime.

Powder Measure Riser
90041 9.98

POWDER THROUGH EXPANDING DIE
pg. 8

NOTE Pro Auto-Disk and Auto-Drum Powder Measures must be used with the powder through expanding die supplied with all Lee pistol dies, or Lee Rifle Charging Dies (see left). These dies may be purchased individually. Sizes listed on page 8.

Only Lee Dies permit charging the case while expanding the case mouth.

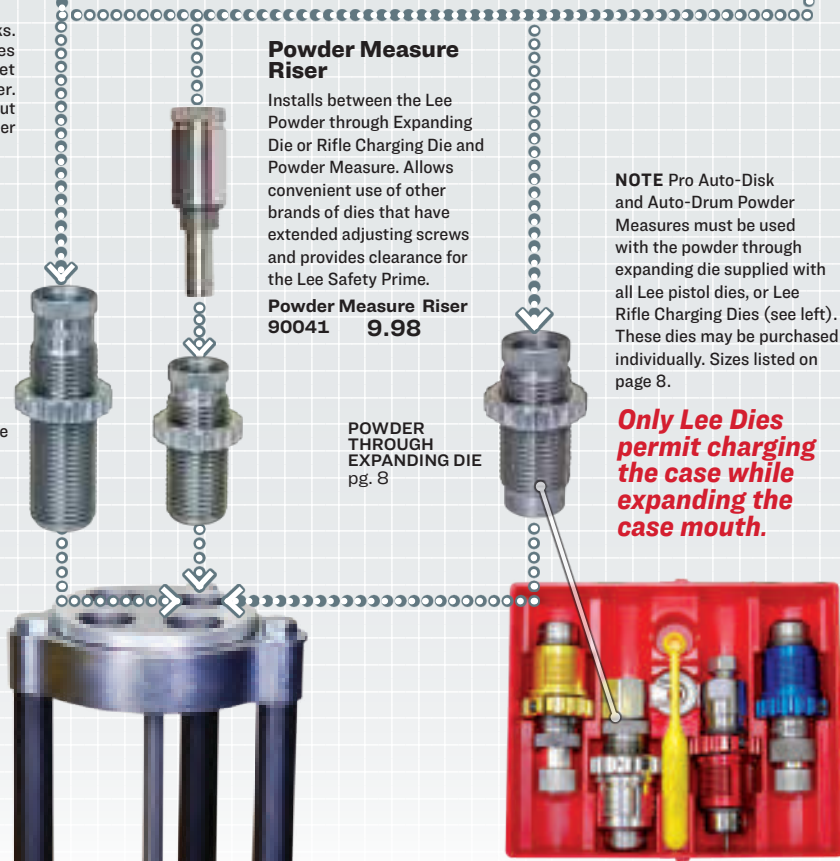



Lee Pro 4-20

Large diameter high capacity pot, holds approximately 20 pounds of lead. Nearly 4 inches of clearance under the spout accepts all brands of bullet molds and most sinker molds. It also includes an adjustable mold guide to quickly and accurately position any mold for pouring.

This second generation design incorporates the famous Lee patented high-efficiency design and dependable remote sensing thermostat, in a dust tight housing. Long life 700-watt tubular heating element assures quick melting and rapid recovery. Micro adjustable, flow control valve adjusts instantly with a twist of the screwdriver. Front mounted low maintenance replaceable valve spout allows instant reseating with a turn of a screwdriver.

| | | | |
|--------------|-------|----------|--------|
| Lee Pro 4-20 | 90947 | 110 Volt | 108.00 |
| Lee Pro 4-20 | 90948 | 220 Volt | 112.00 |



Lee Precision Melter

High speed melter with an infinite heat control for the budget caster. Easily handles 4-cavity molds. Takes less than 15 minutes to melt 4 pounds of metal. Same infinite heat control as used on the Production Pot. 500 watts AC only. Guaranteed 2 years.

| | | |
|------------------------|-------|-------|
| PRECISION MELTER, 110V | 90021 | 58.98 |
| EXPORT MODEL, 220V | 90024 | 60.98 |

LEE MOLD MALLET

Features ash hardwood construction. Cut the sprue and release the bullets with one handy tool. Ergonomic design makes it convenient and comfortable to use with long casting sessions. Mallet is 10 inches long.

90084 10.00



UNIQUE INFINITE HEAT CONTROL

A highly reliable control, mounted away from the high heat of the pot. Eliminates failures usually associated with thermostatically controlled units. Thermal feed back to the infinite control permits heater to put out full power until metal has melted.



Magnum Melter

Large 4" diameter pot allows easy access for the ladle caster. Same high efficiency design that has made Lee pots the most popular. Melt time is less than 20 minutes with just 700 watts. 20-lb. capacity for the longest casting session.

| | | | |
|---------------|----------|-------|-------|
| Magnum Melter | 110 Volt | 90949 | 82.00 |
|---------------|----------|-------|-------|

LEE MAKES BULLET CASTING EASIER

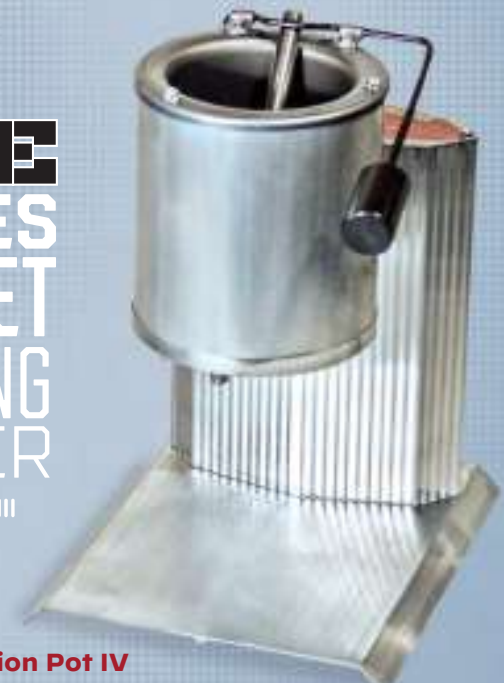

Lee Production Pot IV

Large, deep pot holds approximately 10 pounds of lead. Melt time is less than 20 minutes. Pour spout up front where it belongs so you can see what you're doing. Infinite heat control. Uses only 500 watts of power during heat-up and a lot less to maintain temperature. Large, stable base for safety. 4" of clearance under the spout is high enough to accept all brands of bullet molds and most sinker molds.

| | | | |
|-------------------|----------|-------|-------|
| PRODUCTION POT IV | 110 VOLT | 90009 | 90.98 |
| EXPORT MODEL | 220 VOLT | 90008 | 95.98 |

LEE INGOT MOLD

Use to cast 1/2 and one pound ingots. Perfect for remelting and alloying. Wood handles stay cool. Aluminum mold is lightweight and rustproof.

90029 20.98

LEE LEAD LADLE

A convenient size ladle for bullet casting. Works equally well for right and left handers. Handy for skimming and stirring metal.

90026 6.98

WARNING Melting lead and casting lead objects will expose you and others in the area to lead, which is known to the State of California to cause reproductive harm and cancer. For more information, www.P65Warnings.ca.gov. See instructions on REDUCING EXPOSURE supplied with product.



BREECH LOCK BULLET SIZER KIT

FASTEST AND EASIEST WAY TO SIZE CAST BULLETS

Breech Lock Bullet Sizer Kit

works in any Breech Lock Press. Uses inexpensive bullet sizer and punch, see listing right. >

The quick change body accepts our new, low cost bullet sizer and punch. The new sizer is produced of high carbon steel, and specially tapered to reduce sizing effort.

Bullets are sized nose first—this is the most accurate and causes the least distortion.

Best of all, no special top punches are required. Will seat and crimp gas checks while sizing.

Great for powder coated or liquid lubricated bullets. All bullets must be lubricated, order Lee Liquid Alox or your favorite coating. Order appropriate bullet sizer and punch, see listings at right.

Breech Lock Bullet Sizing Kit

91532 15.00



GET INCREDIBLY FAST BULLET SIZING with the LEE APP

See pg. 27



shown with optional bottle adapter →
91151 6.00

Includes bottle that holds 100 bullets. Adapter also fits most powder containers for larger capacity.

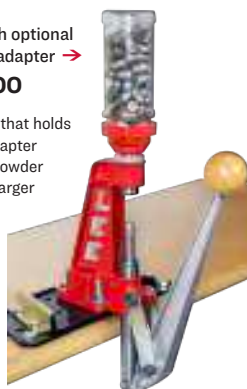

ORDER BULLET SIZER AND PUNCH RIGHT >

Bullet Sizer and Punch 12.00



Other sizes can be made on a custom basis. See web for details.
leeprecision.com/custom-breech-lock-bullet-sizer-punch/

| BULLET DIAMETER | BULLET SIZER & PUNCH 12.00 | CLASSIC BULLET SIZING KIT 25.98 |
|-----------------|----------------------------|---------------------------------|
| .224 | 91505 | 90049 |
| .225 | 91506 | 90036 |
| .243 | 91507 | 90083 |
| .278 | 91508 | 90261 |
| .284 | 91509 | 90170 |
| .285 | 91510 | 90171 |
| .308 | 91511 | 90037 |
| .309 | 91512 | 90038 |
| .311 | 91513 | 90039 |
| .314 | 91514 | 90044 |
| .323 | 91515 | 90686 |
| .329 | 91516 | 90934 |
| .339 | 91517 | 90576 |
| .356 | 91518 | 90046 |
| .357 | 91519 | 90047 |
| .358 | 91520 | 90048 |
| .401 | 91521 | 90060 |
| .410 | 91522 | 90052 |
| .427 | 91523 | 90053 |
| .429 | 91524 | 90054 |
| .430 | 91525 | 90062 |
| .451 | 91526 | 90061 |
| .452 | 91527 | 90055 |
| .454 | 91528 | 90056 |
| .457 | 91529 | 90057 |
| .501 | 91530 | 90191 |
| .510 | 91531 | 90188 |

Bullets must be lubricated for sizing, order Lee Liquid Alox below, good for thousands of bullets.



Classic Bullet Sizing Kit

Standard 7/8 x 14 threads fit any reloading press.

Bullets are pushed through the sizing die nose first, so no special nose punches are needed. Gas checks are automatically seated and crimped in place. Sized bullets captured in the special container. **COMPLETE FOR ONE SIZE 25.98**



Other sizes can be made on a custom basis. See web for details.
leeprecision.com/custom-lube-and-sizing-kit.html



LUBRICATING BULLETS

Try this with your bullet lubricant



Lee Liquid Alox

Enough for thousands of bullets

Lee Liquid Alox gives better accuracy because it eliminates leading. The lube coats the entire bullet like a thin jacket and dries to a soft, varnish-like finish that really clings. The dried coating does not degrade gunpowder. Easy to apply; eliminates the need for sizing of most cast bullets. While it works well with all cast or swaged bullets better than any other lube, it works most economically with micro band bullets, which are designed for tumble lubing.

4 OZ. DISPENSER BOTTLE 90177

6.98



The bullet melts while the Lee Liquid Alox clings tenaciously to the bullet

Traditional bullet lubricating methods of placing lube only in the grooves are inferior to the modern method of coating the entire bullet with Lee Liquid Alox. This places the lube where needed, on the surfaces that rub against the bore.

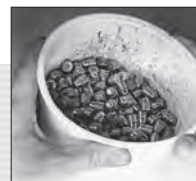

Gently shake bullets in an orbital motion to coat the bullets. If they do not coat completely, add a little more lube.



Spread bullets onto waxed paper and let dry overnight.



Universal Case Expanding Die

Gently flares the case mouth to accept cast bullets without shaving. Works great to prevent damaging the moly and low friction coatings found on today's high performance jacketed bullets. Includes neck plugs for .22 cal through .45 cal. Works on everything from the 22 Hornet to the largest Ultra Mag. Costs so little and works so well you can't afford to be without one.

90798 16.98

Hardness Testing Kit

Featured product in Chapter 10 "Modern Reloading." No more wasted components shooting too soft or too hard lead. Cast and load with confidence knowing your alloy is up to the job. Quickly and precisely check hardness of your lead alloy. Exclusive conversion chart tells the maximum operating pressure of any lead alloy.

90924 95.00 INCLUDES

CALIBRATED HARDENED STEEL BALL INDENTER
V" BLOCK CRADLE SNAPS INTO STANDARD PRESS RAM
20 POWER 4 LENS OPTICAL MEASURING MICROSCOPE



C GAS CHECK
TL Micro Band

309 DIAMETER

230 WEIGHT IN GRAINS

R POINT SHAPE

WC WAD CUTTER
SWC SEMIWAD CUTTER
RF ROUND WITH FLAT
R 1 OGIVE RADIUS
2R 2 OGIVE RADIUS
TC TRUNCATED CONE



LEE MOLD BLOCKS MADE FROM ALUMINUM BECAUSE OF THE EXCEPTIONAL MOLDING QUALITIES

MOLD CAVITIES CNC-MACHINED FOR UNMATCHED ROUNDNESS AND SIZE CONTROL

MOST BULLETS FROM LEE MOLDS CAN BE USED AS CAST WITHOUT SIZING

DOUBLE CAVITY MOLDS

Handles and sprue plate included.

29.98

HOLLOW BASE MOLDS

These are available in single cavity only. They have self centering automatic core pins for the fastest possible molding. Handles and sprue plate included.

30.98

SIX CAVITY COMMERCIAL QUALITY MOLDS

These are made for heavy duty volume production. The mold blocks have steel bushing and alignment pins for lasting precision. Price includes a cam operated sprue plate to eliminate the pounding common to ordinary molds. The sprue plate is hard anodized and held down with wave washers at each end. No finer mold can be purchased at any price. Handles extra.

59.00

MOLD HANDLES

Precision steel mold handles fit not only the Lee Six Cavity molds and 18 Cavity Buckshot molds, but most other brands of one and two cavity molds. Priced low enough so you can have a set for every pair of blocks.

90005

25.98



TRADITIONAL GROOVE

This type of lubrication groove is designed for old style hard lubricants. Also works well with Lee Liquid Alox.



MICRO BAND GROOVE FOR LIQUID ALOX #90177

The reduced friction of the micro bands allow a higher velocity with the same pressure as conventional lube grooves.

MICRO BANDS USUALLY REQUIRE NO SIZING

The bullet shank has many shallow grooves for maximum liquid lubricant retention. A great way to make bullets in quantity with minimum time, effort and equipment. More accurate than ordinary cast bullets. The reduced friction of the micro bands gives you more velocity with less pressure.

RIFLE BULLET MOLDS

| | RIFLE BULLET MOLDS | | | | | | | | | | | | | |
|----------------------------|---------------------|---------------------|---------------------|---------------------|--------------------|-----------------------|--------------------|--------------------|--------------------|--------------------|----------------------|----------------------------------------------|---------------------------------|---------------------|
| | 22 CAL | 270 | 7mm | 30 CALIBER RIFLE | | | | | | | | BEST SUBSONIC REQUIRES FAST TWIST RIFLING | 7.62 X 39 Bullet Design C.E. | 303 B |
| | | | | | | | | | | | | | | |
| BALLISTIC COEFFICIENT MOLD | .155 C225-55-RF | .310 C277-135-RF | .305 C285-130-R | .154 C309-113-F | .163 C309-120-R | .224 C309-150-F | .252 C309-160-R | .268 C309-170-F | .317 C309-180-R | .352 C309-200-R | .688 TL309-230-5R | .268 C312-155-2R | .276 CTL312-160-2R | .247 C312-185-1R |
| DOUBLE | 90451 | 90454 | 90360 | 90362 | 90364 | 90366 | 90367 | 90368 | 90369 | 90370 | 90307 | 90385 | 90361 | 90371 |
| 6 CAVITY | 90459 | | | | | | | | | | | 90741 | 90579 | |
| LUBE & SIZE | 90036 | 90261 | 90171 | 90038 | 90038 | 90038 | 90038 | 90038 | 90038 | 90038 | 90038 | 90039 | 90039 | 90039 |
| BL BULLET SIZER | 91506 | 91508 | 91510 | 91512 | 91512 | 91512 | 91512 | 91512 | 91512 | 91512 | 91512 | 91513 | 91513 | 91513 |
| | 8mm | 8 x 56 | 338 CAL | 35 REM | 375 Win 38/55 | 45 - 70 CALIBER RIFLE | | | | | | 50 - 70 CAL | | |
| | | | | | | | | | | | | | | |
| BALLISTIC COEFFICIENT MOLD | .216 C324-175-1R | .361 C330-205-1R | .250 C338-220-1R | .186 C358-200-RF | .250 379-250-RF | .211 457-340-F | .225 457-405-F | .250 459-405-HB | .250 457-450-F | .278 C457-500-F | .443 459-500-3R | .220 515-450-F | .283 515-500-F | |
| DOUBLE | 90274 | 90775 | 90372 | 90449 | 90324 | 90373 | 90374 | | 90375 | 90376 | 90577 | 90255 | 90266 | |
| 6 CAVITY | | | | 90016 | | | | | | | | | | |
| HOLLOW | | | | | | | | 90268 | | | | | | |
| LUBE & SIZE | 90686 | custom | 90576 | 90048 | custom | 90057 | 90057 | custom | 90057 | 90057 | custom | custom | custom | |
| BL BULLET SIZER | 91515 | custom | 91517 | 91520 | custom | 91529 | 91529 | custom | 91529 | 91529 | custom | custom | custom | |

LEE MOLDS FEATURE TROCHOIDAL VENTING

Unique venting on the mold face and sprue plate mating surface allows consistent and effortless fill out.



PISTOL BULLET MOLDS

| | 32/20 · 32S&W LONG · 32 COLT NP | | | 38 SPECIAL · 38 S & W · 38 COLT NEW POLICE · 357 MAG | | | | | | | | | |
|----------------------------|---------------------------------|------------|--------------|------------------------------------------------------|------------|-------------|--------------|------------|------------|---------------|--------------|--------------|------------|
| | | | | | | | | | | | | | |
| BALLISTIC COEFFICIENT MOLD | .125 | .174 | .100 | .106 | .116 | .142 | .072 | .072 | .131 | .117 | .117 | .207 | .160 |
| DOUBLE | 311-93-1R | 311-100-2R | TL314-90-SWC | 358-105-SWC | 358-125-RF | 358-140-SWC | TL358-148-WC | 358-148-WC | 358-150-1R | TL358-158-SWC | C358-158-SWC | TL358-158-2R | 358-158-RF |
| 6 CAVITY | 90300 | 90301 | 90311 | 90316 | 90574 | 90318 | 90279 | 90312 | 90328 | 90321 | 90322 | 90388 | 90303 |
| LUBE&SIZE | 90308 | 90039 | 90044 | 90315 | 90306 | 90317 | 90294 | 90380 | 90326 | 90295 | 90327 | 90319 | 90692 |
| BL BULLET SIZER | 91513 | 91513 | 91514 | 91520 | 91520 | 91520 | 91520 | 91520 | 91520 | 91520 | 91520 | 91520 | 91520 |

| | 9MM LUGER · 38 SUPER AUTO · 380 AUTO | | | | | | 9mm MAKAROV | 40 S&W · 10 MM AUTO | | | 41 MAGNUM | | 44 SPEC · 44 MAG · 44/40 | |
|----------------------------|--------------------------------------|------------|------------|--------------|--------------|------------|-------------|---------------------|--------------|------------|-------------|--------------|--------------------------|--------------|
| | | | | | | | | | | | | | | |
| BALLISTIC COEFFICIENT MOLD | .107 | .105 | .123 | .164 | .127 | .166 | .093 | .117 | .141 | .141 | .110 | .119 | .111 | .124 |
| DOUBLE | TL356-95-RF | 356-102-1R | 356-120-TC | TL356-124-2R | TL356-124-TC | 356-125-2R | 365-95-1R | 401-145-SWC | TL401-175-WC | 401-175-TC | 410-195-SWC | TL410-210-WC | 429-214-SWC | C429-240-SWC |
| 6 CAVITY | 90601 | 90305 | 90239 | 90464 | 90238 | 90309 | 90466 | 90470 | 90431 | 90256 | 90330 | 90335 | 90336 | 90338 |
| LUBE&SIZE | 90672 | | 90387 | 90465 | 90402 | 90457 | | | 90433 | 90690 | | | | 90483 |
| BL BULLET SIZER | 90046 | 90046 | 90046 | 90046 | 90046 | 90046 | custom | 90060 | 90060 | 90060 | 90052 | 90052 | 90054 | 90054 |
| | 91518 | 91518 | 91518 | 91518 | 91518 | 91518 | custom | 91521 | 91521 | 91521 | 91522 | 91522 | 91524 | 91524 |

| | 44 SPECIAL · 44 MAGNUM · 44/40 | | | | | | 45 ACP · 45 AUTO RIM · 45 COLT | | | | | |
|----------------------------|--------------------------------|------------|---------------|-------------|------------|-------------|--------------------------------|---------------|------------|--------------|--------------|------------|
| | | | | | | | | | | | | |
| BALLISTIC COEFFICIENT MOLD | .124 | .196 | .169 | .218 | .090 | .127 | .140 | .127 | .145 | .189 | .146 | .146 |
| DOUBLE | 429-200-RF | 429-240-2R | TL430-240-SWC | C430-310-RF | 452-160-RF | 452-200-SWC | 452-200-RF | TL452-200-SWC | 452-228-1R | TL452-230-2R | TL452-230-TC | 452-230-TC |
| 6 CAVITY | 90285 | 90341 | 90299 | 90858 | 90570 | 90348 | 90234 | 90463 | 90351 | 90346 | 90287 | 90290 |
| LUBE&SIZE | 90428 | 90339 | 90357 | 90227 | | 90310 | 90697 | 90379 | 90352 | 90350 | 90286 | 90289 |
| BL BULLET SIZER | 90054 | 90054 | 90062 | 90062 | 90055 | 90055 | 90055 | 90055 | 90055 | 90055 | 90055 | 90055 |
| | 91524 | 91524 | 91525 | 91525 | 91527 | 91527 | 91527 | 91527 | 91527 | 91527 | 91527 | 91527 |

| | 45 ACP 45 AUTO RIM 45 COLT | 45 COLT 454 CASULL | 475 LINEBAUGH | 500 S&W |
|----------------------------|--------------------------------|----------------------|---------------|------------|
| | | | | |
| BALLISTIC COEFFICIENT MOLD | .136 | .210 | .233 | .271 |
| DOUBLE | 452-252-SWC | 452-255-RF | C452-300-RF | 476-400-RF |
| 6 CAVITY | 90356 | 90358 | 90359 | 90241 |
| LUBE&SIZE | 90055 | 90055 | 90055 | custom |
| BL BULLET SIZER | 91527 | 91527 | 91527 | 91530 |

CUSTOM MOLDS We can produce custom bullet molds within certain limits. The prices are the same as our standard molds, but there is a tooling and set-up charge of \$250.00. If interested in this service, please access design assistance sheet on www.leeprecision.com. This outlines the basic limitations of our manufacturing process.

CUSTOM BREECH LOCK BULLET SIZERS



WARNING Melting lead and casting lead objects will expose you and others in the area to lead, which is known to the State of California to cause reproductive harm and cancer. For more information, www.P65Warnings.ca.gov. See instructions on REDUCING EXPOSURE supplied with product.

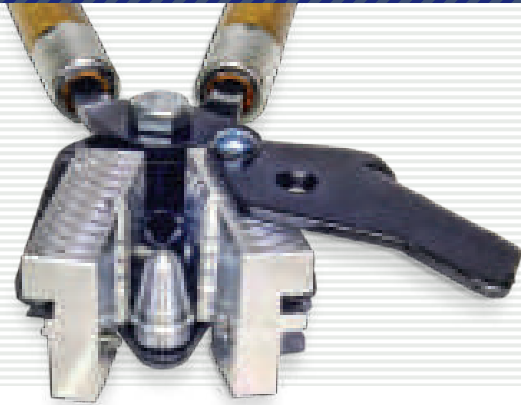

Cast Minie Bullets as fast as Round Balls

Minie Bullet Mold

Automatic Core Pin Mold. Open mold upside down to empty. Close it and you're ready to cast the next. The core pin automatically centers in the mold. Easily cast 200 per hour. A quality mold built to last as long as your rifle.

COMPLETE w/ HANDLES and AUTOMATIC CORE PIN 39.98

Round Ball Molds

Have tangential cut off which eliminates the objectional nib at the sprue.

DOUBLE CAVITY WITH HANDLES 29.98
6-CAVITY WITHOut HANDLES 59.00

| SIZE | DOUBLE | SIZE | DOUBLE | SIZE | DOUBLE |
|------|--------|------|--------|---------------------------------------------------------------------|----------|
| .311 | 90406 | .440 | 90436 | .535 | 90456 |
| .319 | 90410 | .445 | 90438 | .562 | 90460 |
| .350 | 90415 | .451 | 90440 | .575 | 90461 |
| .360 | 90418 | .454 | 90442 | .600 | 90975 |
| .375 | 90420 | .457 | 90444 | SIZE | SINGLE |
| .380 | 90423 | .490 | 90448 | .690 | 90978* |
| .390 | 90424 | .495 | 90450 | <small>*Due to the diameter, mold ships as a single cavity.</small> | |
| .395 | 90425 | .500 | 90452 | SIZE | 6 CAVITY |
| .433 | 90432 | .530 | 90283 | .490 | 91711▲ |

▲ Handles #90005 25.98



Improved Minie, Traditional Design

| | | |
|------------------|-----------|-------|
| 45 Cal. | .450-294M | 90467 |
| 45 Cal. oversize | .454-298M | 90469 |
| 50 Cal. | .500-360M | 90472 |
| 54 Cal. | .533-410M | 90473 |
| 54 Cal. oversize | .540-415M | 90474 |
| 58 cal. | .575-472M | 90476 |
| 58 cal. oversize | .578-478M | 90478 |

Improved design is easier to cast and load. Usually more accurate; a wider variety of sizes.



Modern Minie, Target Design

| | | |
|---------|-----------|-------|
| 50 Cal. | .500-354M | 90471 |
|---------|-----------|-------|

The most accurate of all Minies. Makes nice, clean holes in the target. The first choice for highest scores.



Original Style Minie Bullet

| | | |
|------------|----------|-------|
| 58 Caliber | 575-500M | 90481 |
|------------|----------|-------|

An extremely popular, traditional size Minie bullet. Available in 58 caliber only. Certainly a must for authentic muzzle loading shooting.



RIFLING • ENGRAVED • AT • LOADING

A solid bullet that loads easily even after many firings because of its unique cleaning action. Will not tumble. A perfect hunting bullet with heavy loads. Easy to cast. Shoots accurately even in greatly oversize barrels.

DOUBLE CAVITY WITH HANDLES 29.98

| | Grains | Double |
|---------|--------|--------|
| 45 Cal. | 200 | 90390 |
| 45 Cal. | 250 | 90392 |
| 50 Cal. | 250 | 90394 |
| 50 Cal. | 320 | 90396 |
| 54 Cal. | 300 | 90398 |
| 54 Cal. | 380 | 90400 |
| 58 Cal. | 440 | 90404 |



Combo Molds

45 CAL 200RB with Handles 90405 29.98

Double cavity mold casts one 45 Cal. 200 R-E-A-L bullet and one .440 diameter Round Ball.

50 CAL 320RB with Handles 90488 29.98

Double cavity mold casts one 50 Cal. 320 R-E-A-L bullet and one .490 diameter Round Ball.

RIFLING-ENGRAVED-AT-LOADING

The driving bands are large enough to adequately engage the rifling when pushed into the muzzle, and thin enough to easily engrave. They're strong enough to withstand maximum charges without stripping or gas cutting.

UNIQUE CLEANING ACTION You can shoot all day without cleaning your rifle between shots! When inserted into the muzzle, tiny scraping edges are swagged forward on each driving band. These perfect fitting scrapers remove the fouling from the previous shot.

EASIER, FASTER TO LOAD It's easy to load straight and true, easier and faster than a round ball with patch. Easily stabilized with very light

charges, the R-E-A-L bullet also retains accuracy with maximum loads. Each band is generously tapered to the rear with an angle close to that of a lathe center, so as to center the bullet against the rifle bands. When pushed in, the bullet automatically centers in the bore.

MORE ACCURATE The bevel base of the R-E-A-L bullet contributes to greater accuracy. When the bullet exits the bore, the gas escapes equally around the perimeter of the base. The uniform bevel is resistant to nicks that would permit gas to escape prematurely and cause a jet effect on one side of the bullet.



Conical Bullet Mold FOR BLACK POWDER REVOLVERS

A super accurate bullet that is easy to load straight and true. Two lube grooves prevent flash ignition and lead fouling. More energy and far greater accuracy than round balls.

29.98
DOUBLE

| | |
|------------------------------|-------|
| 36 Cal. 375-130-1R | 90378 |
| 44 Cal. Rem. 450-200-1R | 90382 |
| 44 Ruger Old Army 456-220-1R | 90384 |



WARNING Melting lead and casting lead objects will expose you and others in the area to lead, which is known to the State of California to cause reproductive harm and cancer. For more information, www.P65Warnings.ca.gov. See instructions on REDUCING EXPOSURE supplied with product.



LOAD SLUGS FOR LESS THAN STANDARD TRAPLOADS

Lee Slug Mold

Load slugs for less than standard trap loads. The Lee DRIVE KEY slug is loaded in standard trap hull with standard wad and conventional folded crimp. Slug loads are produced with any standard shot shell reloading press.

Lee Slug Mold features the exclusive drive key. The drive key positively rotates the slug in rifled shotgun barrels and doubles as a support rib allowing use of a standard trap wad—no need for a support wad or base filler. Sabot wad design outperforms rifled slugs in rifled slug barrels. Velocity and accuracy meet and exceed expensive factory loaded rifled slugs. Molds feature self centering automatic core pins for maximum speed and convenience. Mold is complete with sprue plate, handles and complete instructions with suggested loads.

| | | | | |
|-------------------|---------|--------|-------|-------|
| Shotgun Slug Mold | 1 oz. | 12 ga. | 90281 | 42.98 |
| Shotgun Slug Mold | 7/8 oz. | 12 ga. | 90282 | 42.98 |

EXCLUSIVE DRIVE KEY POSITIVELY ROTATES THE SLUG IN RIFLED BARRELS AND ELIMINATES THE NEED FOR SUPPORT WADS OR BASE FILLERS; ASSURES POSITIVE AND SMOOTH DISCARD OF THE SABOT WAD.

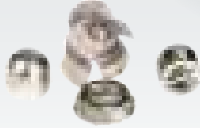

GUARANTEED MORE ACCURATE than factory slugs or your money back



18 CAVITY BUCKSHOT BULLET MOLDS



Lee 18 Cavity Buckshot Bullet Molds

Precision-machined molds produce 18 linked pellets per cast. Each cast produces enough pellets to load two 12 Gauge shotshells. Easily cast 3,000 pellets per hour. Handles shown not included. Order product No. 90005 on page 36.

| | | |
|---------------------------------|--------------|--------------|
| Ball diameter .240 #4 BUCKSHOT | 90028 | 70.00 |
| Ball diameter .330 00 buckshot | 90486 | |
| Ball diameter .360 000 Buckshot | 90192 | |
| HANDLES | 90005 | 25.98 |

WARNING Melting lead and casting lead objects will expose you and others in the area to lead, which is known to the State of California to cause reproductive harm and cancer. For more information, www.P65Warnings.ca.gov. See instructions on REDUCING EXPOSURE supplied with product.

LOAD SHOTGUN SHELLS, STEEL OR LEAD SHOT, TO LOOK AND SHOOT LIKE NEW

Lee Load-All II

Lee Load-All II shotgun shells not only look better than those loaded on machines costing hundreds of dollars, but they usually have more uniform velocity and patterns. You can load just as fast as with any other brand of loader costing up to \$200.

Twenty-four shot and powder bushings are included free. The bushings alone can cost several dollars each from other manufacturers— and they're not as accurate as those made by Lee. Only Lee supplies molded bushings.

This is a time proven tool. There are hundreds of thousands in use world wide: in nearly forty years, we have yet to see one worn out. Written two-year unconditional guarantee and a lifetime warranty.

| | |
|-----------------|--------------|
| Lee Load-All II | 79.98 |
| 12 GAUGE | 90011 |
| 16 GAUGE | 90015 |
| 20 GAUGE | 90012 |



Load-All Options

Conversion To Another Gauge

The Load-All II can be easily and economically converted to another gauge with the conversion kit. The entire die carrier is replaced so no adjustments are needed. The conversion kit includes the die carrier, steel sizer, wad guide, shell holder, load data and instructions.

| | |
|-----------------------|--------------|
| CONVERSION KIT | 27.98 |
| 12 GAUGE | 90070 |
| 16 GAUGE | 90071 |
| 20 GAUGE | 90072 |

Lee Adjustable Shot Dipper

Accurately measure lead, bismuth and steel. Telescoping cup adjustable from 7/8 to 1 1/8 oz. Calibrated for lead shot. Works perfect for large pellet sizes. With steel, simply count out the pellets or weigh and set dipper accordingly.

90973 **3.98**



OUR PRODUCTION FACILITIES IN HARTFORD, WISCONSIN

Thank you for choosing
**LEE PRECISION
PRODUCTS**

FROM THE CORNER of a one-car garage to nearly two acres under roof — for more than 60 years, the LEE family still continues to provide the best value in American made reloading equipment. Our family looks forward to another lifetime of supplying the best, most economical reloading equipment in the business.

• JOHN LEE | PRESIDENT •

The Lee Guarantee

LEE RELOADING PRODUCTS ARE GUARANTEED NOT TO WEAR OUT OR BREAK FROM NORMAL USE FOR TWO FULL YEARS OR THEY WILL BE REPAIRED OR REPLACED AT NO CHARGE, IF RETURNED TO THE FACTORY. ANY LEE PRODUCT OF CURRENT MANUFACTURE, REGARDLESS OF AGE OR CONDITION, WILL BE RECONDITIONED TO NEW, INCLUDING NEW GUARANTEE, IF RETURNED TO THE FACTORY WITH PAYMENT EQUAL TO HALF THE CURRENT RETAIL PRICE ⚡

AUTO BENCH PRIME | AUTO BREECH LOCK PRO | AUTO-DRUM | BREECH LOCK | CLASSIC CAST LOAD-MASTER | LEVER PRIME SYSTEM | LEE LOADER | LOAD-ALL II | RGB FACTORY CRIMP | PACESETTER | PERFECT POWDER MEASURE | SAFETY SCALE | AUTO-PRIME BULGE BUSTER | MICRO-BAND DRIVE KEY | R-E-A-L | ARE TRADEMARKS OF LEE PRECISION, INC.

LEE

www.leeprecision.com

LEE PRECISION, INC. 4275 HIGHWAY U HARTFORD WISCONSIN 53027 262 673 3075

PRINTED IN THE USA | 111320